

EXTERIOR VIVE EL VALOR DE LA LUZ

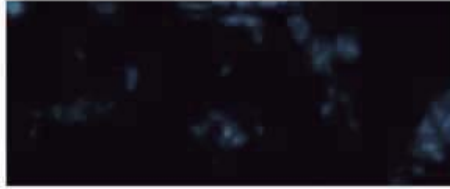

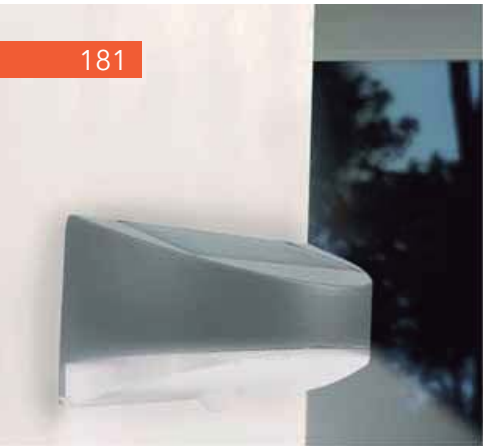

PARA ENRIQUECER
TUS AMBIENTES



DECORATIVA
VIVE LA ARMONÍA
QUE LA LUZ APORTA
A TUS **MOMENTOS**





SENSOR DE MOVIMIENTO

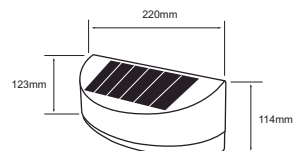

SOL-LED/01
AALBORG

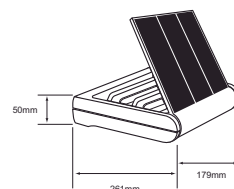

SOL-LED/02
AARHUS



SENSOR DE MOVIMIENTO

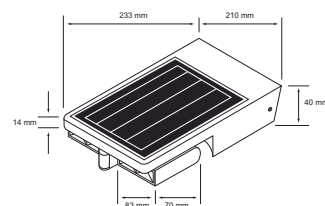

SOL-LED/03
ABERDEEN

PRODUCTO	TERMINADO DEL PRODUCTO	APLICACIÓN	LÚMENES	POTENCIA	TEMPERATURA DE COLOR	IRC	TIEMPO DE VIDA	TIPO DE LÁMPARA	ÁNGULO	INCLUYE	IP	OBSERVACIONES
SOL-LED/01	Gris	Muro	100 lm	1.2 W	4000K	80	25 000 h	LED	120°	Driver LED, panel solar y batería	45	Ahorrador. Incluye apagador.
SOL-LED/02	Gris	Muro	160 lm	2.2 W	4000K	80	20 000 h	LED	120°	Driver LED, panel solar y batería	45	Ahorrador. Incluye apagador. Dirigible.
SOL-LED/03	Gris	Muro	400 lm	4 W	4000K	80	25 000 h	LED	120°	Driver LED, panel solar y batería	45	Ahorrador. Incluye apagador. Dirigible.

*Tecnolite se reserva el derecho de modificar la información sin previo aviso y no se hace responsable por errores u omisiones en este documento.



SENSOR DE MOVIMIENTO

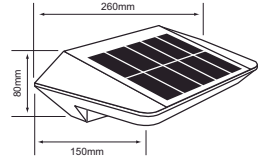

SOL-LED/04
ABIDJAN



Uso opcional como lámpara de emergencia

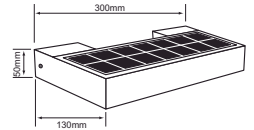

SOL-LED/05
ABOU



SENSOR DE MOVIMIENTO

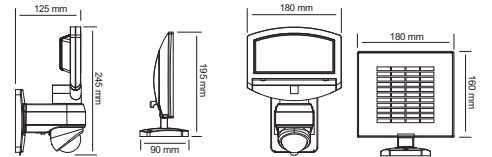

SOL-LED/06/3W/40
PANSOL



PRODUCTO	TERMINADO DEL PRODUCTO	APLICACIÓN	LÚMENES	POTENCIA	TEMPERATURA DE COLOR	IRC	TIEMPO DE VIDA	TIPO DE LÁMPARA	ÁNGULO	INCLUYE	IP	OBSERVACIONES
SOL-LED/04	Gris	Muro	220 lm	2.4 W	4000K	80	25 000 h	LED	85°	Driver LED, panel solar y batería	45	Ahorrador. Incluye apagador
SOL-LED/05	Negro	Muro	280 lm	2.8 W	4000K	80	20 000 h	LED	120°	Driver LED, panel solar y batería	45	Ahorrador. Incluye apagador
SOL-LED/06/3W/40	Negro	Muro	210 lm	3.2 W	4000K	80	30 000 h	LED	100°	Driver LED, panel solar y batería	45	Ahorrador. Incluye apagador

*Tecnolite se reserva el derecho de modificar la información sin previo aviso y no se hace responsable por errores u omisiones en este documento.



Batería Recargable
Dura hasta 5 hrs.

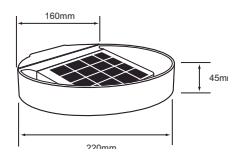

SOL-LED/07
ABUJA



Batería Recargable
Dura hasta 24 hrs.

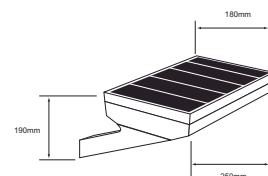

SOL-LED/08
ADDIS



Batería Recargable
Dura hasta 3 hrs.



SENSOR DE MOVIMIENTO

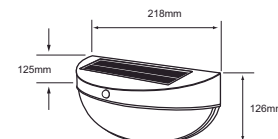

SOL-LED/09
DRACONIS

PRODUCTO	TERMINADO DEL PRODUCTO	APLICACIÓN	LÚMENES	POTENCIA	TEMPERATURA DE COLOR	IRC	TIEMPO DE VIDA	TIPO DE LÁMPARA	ÁNGULO	INCLUYE	IP	OBSERVACIONES
SOL-LED/07	Gris	Muro	90 lm	1 W	4000K	80	25 000 h	LED	100°	Driver LED, panel solar y batería	45	Ahorrador. Incluye apagador
SOL-LED/08	Gris	Muro	250 lm	2.4 W	4000K	80	20 000 h	LED	120°	Driver LED, panel solar y batería	45	Ahorrador. Incluye apagador
SOL-LED/09	Satinado	Muro	200 lm	2.5 W	4000K	80	20 000 h	LED	104°	Driver LED, panel solar y batería	44	Ahorrador. Incluye apagador

*Tecnolite se reserva el derecho de modificar la información sin previo aviso y no se hace responsable por errores u omisiones en este documento.

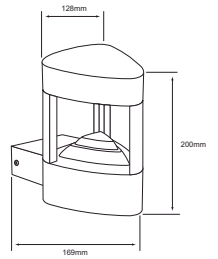

HLED-406/30/G
ASTATUS

PRODUCTO	TERMINADO DEL PRODUCTO	APLICACIÓN	LÚMENES	POTENCIA	VOLTS	TEMPERATURA DE COLOR	IRC	TIEMPO DE VIDA	TIPO DE LÁMPARA	ÁNGULO	INCLUYE	IP	OBSERVACIONES
HLED-406/30/G	Gris	Muro	260 lm	9 W	100-240 V ~	3000 K	80	30 000 h	LED	120°	Driver LED	54	Ahorrador

*Tecnolite se reserva el derecho de modificar la información sin previo aviso y no se hace responsable por errores u omisiones en este documento.

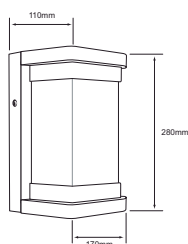

HLED-201/N
CRUX

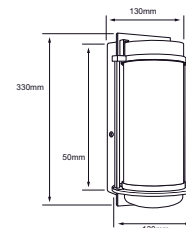

HLED-202/30/N
TUTTLE

EXTERIOR / DECORATIVA / MUROS LED



Textura Luz

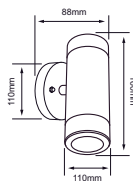

HLED-1105/S
ENCKE

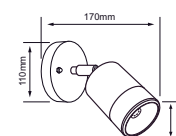

HLED-761/S
ZINNER

PRODUCTO	TERMINADO DEL PRODUCTO	APLICACIÓN	LÚMENES	POTENCIA	VOLTS	TEMPERATURA DE COLOR	IRC	TIEMPO DE VIDA	TIPO DE LÁMPARA	ÁNGULO	INCLUYE	IP	OBSERVACIONES
HLED-201/N	Negro	Muro	800 lm	16 W	100-127 V ~	3000 K	80	20 000 h	LED	120°	Driver LED	44	Ahorrador
HLED-202/30/N	Negro	Muro	730 lm	16 W	100-127 V ~	3000 K	80	20 000 h	LED	12°	Driver LED	44	Ahorrador
HLED-1105/S	Satinado	Muro	600 lm	9 W	100-127 V ~	3000 K	80	20 000 h	LED	49°	Driver LED	44	Ahorrador
HLED-761/S	Satinado	Muro	300 lm	4.5 W	100-127 V ~	3000 K	80	20 000 h	LED	49°	Driver LED	44	Ahorrador

*Tecnolite se reserva el derecho de modificar la información sin previo aviso y no se hace responsable por errores u omisiones en este documento.



HLED-921
SPECTRUM
N: NEGRO
S: SATINADO

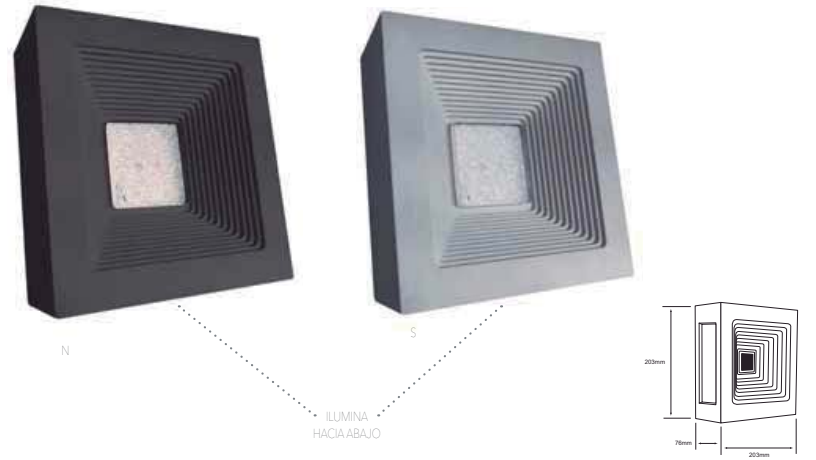
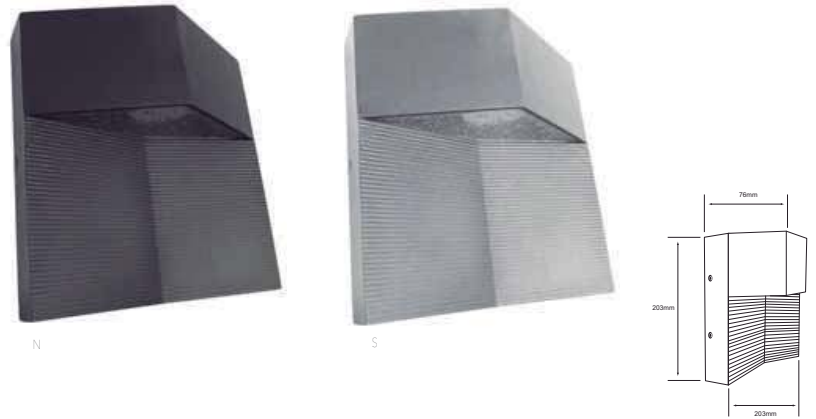

HLED-155
QUADRATA
N: NEGRO
S: SATINADO

PRODUCTO	TERMINADO DEL PRODUCTO	APLICACIÓN	LÚMENES	POTENCIA	VOLTS	TEMPERATURA DE COLOR	IRC	TIEMPO DE VIDA	TIPO DE LÁMPARA	ÁNGULO	INCLUYE	IP	OBSERVACIONES
HLED-921/N	Negro	Muro	400 lm	8 W	100-240 V ~	3000 K	80	15 000 h	LED	65°	Driver LED	55	Ahorrador
HLED-921/S	Satinado	Muro	400 lm	8 W	100-240 V ~	3000 K	80	15 000 h	LED	65°	Driver LED	55	Ahorrador
HLED-155/N	Negro	Muro	600 lm	12 W	100-240 V ~	3000 K	80	15 000 h	LED	92°	Driver LED	55	Ahorrador
HLED-155/S	Satinado	Muro	600 lm	12 W	100-240 V ~	3000 K	80	15 000 h	LED	92°	Driver LED	55	Ahorrador

*Tecnolite se reserva el derecho de modificar la información sin previo aviso y no se hace responsable por errores u omisiones en este documento.

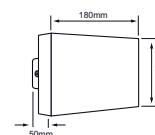
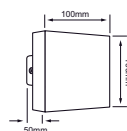
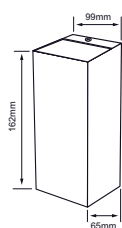

HLED-847/30/G
HYADUM

HLED-407/G
PLEYONE

HLED-408/G
TAIGETE

EXTERIOR / DECORATIVA / MUROS LED

PRODUCTO	TERMINADO DEL PRODUCTO	APLICACIÓN	LÚMENES	POTENCIA	VOLTS	TEMPERATURA DE COLOR	IRC	TIEMPO DE VIDA	TIPO DE LÁMPARA	ÁNGULO	INCLUYE	IP	OBSERVACIONES
HLED-847/30/G	Gris	Muro	420 lm	9 W	100-127 V ~	3000 K	80	20 000 h	LED	41°	Driver LED	44	Ahorrador
HLED-407/G	Gris	Muro	500 lm	9.5 W	100-127 V ~	3000 K	80	20 000 h	LED	22°	Driver LED	44	Ahorrador
HLED-408/G	Gris	Muro	750 lm	17 W	100-127 V ~	3000 K	80	20 000 h	LED	19°	Driver LED	44	Ahorrador

*Tecnolite se reserva el derecho de modificar la información sin previo aviso y no se hace responsable por errores u omisiones en este documento.

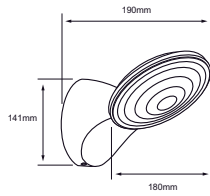

HLED-1176/30/G
POLUX

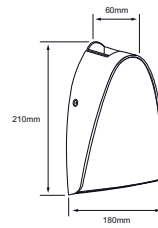

HLED-1152/G
PERSEIDA

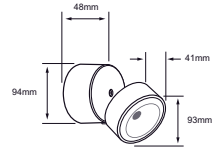

HLED-1178/30/G
PROCYON



PRODUCTO	TERMINADO DEL PRODUCTO	APLICACIÓN	LÚMENES	POTENCIA	VOLTS	TEMPERATURA DE COLOR	IRC	TIEMPO DE VIDA	TIPO DE LÁMPARA	ÁNGULO	INCLUYE	IP	OBSERVACIONES
HLED-1176/30/G	Gris	Muro	600 lm	8.5 W	100-240 V ~	3000 K	80	20 000 h	LED	102 °	Driver LED	44	Ahorrador
HLED-1152/G	Gris	Muro	600 lm	16 W	100-127 V ~	3000 K	80	20 000 h	LED	-	Driver LED	54	Ahorrador
HLED-1178/30/G	Gris	Muro	800 lm	10 W	100-127 V ~	3000 K	80	20 000 h	LED	107 °	Driver LED	54	Ahorrador

*Tecnolite se reserva el derecho de modificar la información sin previo aviso y no se hace responsable por errores u omisiones en este documento.

LED

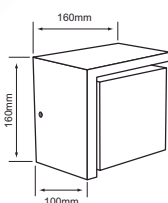

HLED-1051/30/G
COPEINA

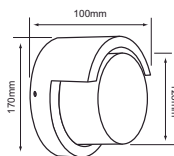

HLED-1052/30/G
COPEINA I



EXTERIOR / DECORATIVA / MUROS LED

PRODUCTO	TERMINADO DEL PRODUCTO	APLICACIÓN	LÚMENES	POTENCIA	VOLTS	TEMPERATURA DE COLOR	IRC	TIEMPO DE VIDA	TIPO DE LÁMPARA	ÁNGULO	INCLUYE	CORTE DE EMPOTRAMIENTO	OBSERVACIONES
HLED-1051/30/G	Gris	Muro	900 lm	15 W	100-240V ~	3000 K	80	15 000 h	LED	130°	Driver LED	65	Ahorrador
HLED-1052/30/G	Gris	Muro	900 lm	15 W	100-240V ~	3000 K	80	15 000 h	LED	130°	Driver LED	65	Ahorrador

*Tecnolite se reserva el derecho de modificar la información sin previo aviso y no se hace responsable por errores u omisiones en este documento.



HLED-1173/30/S
CORIDORA

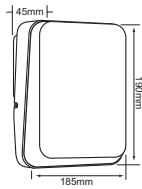

HLED-117/30/N
ACANTHUS

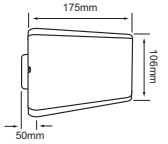

HLED-370/N
AL MANAMA

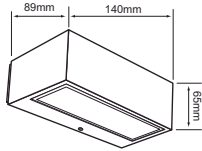

HLED-371/N
AL MANAMA I

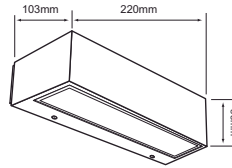

HLED-410/20W/40
AACHEN

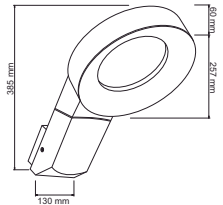

PRODUCTO	TERMINADO DEL PRODUCTO	APLICACIÓN	LÚMENES	POTENCIA	VOLTS	TEMPERATURA DE COLOR	IRC	TIEMPO DE VIDA	TIPO DE LÁMPARA	ÁNGULO	INCLUYE	IP	OBSERVACIONES
HLED-1173/30/S	Satinado	Muro	650 lm	14.5 W	100-240 V ~	3000 K	80	20 000 h	LED	120°	Driver LED	54	Ahorrador
HLED-117/30/N	Negro	Muro	600 lm	12 W	100-240 V ~	3000 K	80	15 000 h	LED	258°	Driver LED	65	Ahorrador
HLED-370/N	Negro	Muro	450 lm	9 W	100-240 V ~	4000 K	80	20 000 h	LED	30°	Driver LED	45	Ahorrador
HLED-371/N	Negro	Muro	1 200 lm	20 W	100-240 V ~	4000 K	80	20 000 h	LED	30°	Driver LED	45	Ahorrador
HLED-410/20W/40	Gris	Muro	1 400 lm	20 W	100-127 V ~	4000 K	80	30 000 h	LED	120°	Driver LED	65	Ahorrador

*Tecnolite se reserva el derecho de modificar la información sin previo aviso y no se hace responsable por errores u omisiones en este documento.

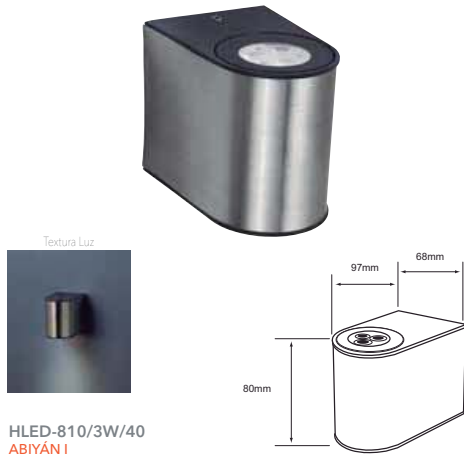

HLED-810/3W/40
ABIYÁN I



HLED-810/6W/40
ABIYÁN



HLED-401/7.5W/30/B
ZIBO

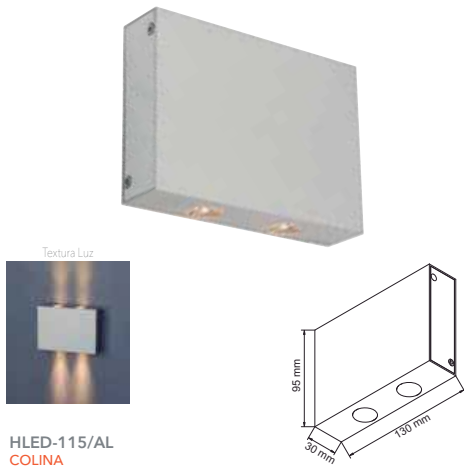

HLED-115/AL
COLINA

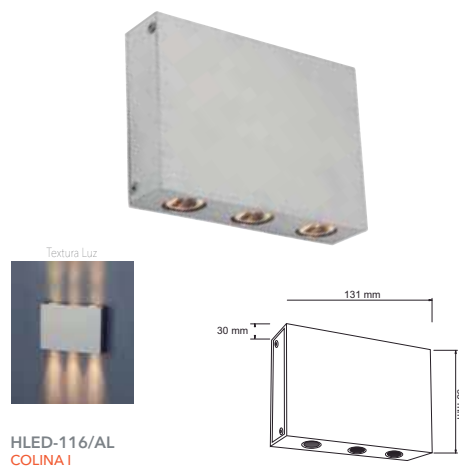

HLED-116/AL
COLINA I



HLED-402/7.5W/30/B
ZIGONG

EXTERIOR / DECORATIVA / MUROS LED

PRODUCTO	TERMINADO DEL PRODUCTO	APLICACIÓN	LÚMENES	POTENCIA	VOLTS	TEMPERATURA DE COLOR	IRC	TIEMPO DE VIDA	TIPO DE LÁMPARA	ÁNGULO	INCLUYE	IP	OBSERVACIONES
HLED-810/3W/40	Satinado	Muro	240 lm	4 W	100-240 V ~	4000 K	80	25 000 h	LED	45°	Driver LED	54	Ahorrador
HLED-810/6W/40	Satinado	Muro	500 lm	6 W	100-240 V ~	4000 K	80	25 000 h	LED	45°	Driver LED	54	Ahorrador
HLED-401/7.5W/30/B	Blanco	Muro	250 lm	7.5 W	100-240 V ~	3000 K	80	20 000 h	LED	155°	Driver LED	45	Ahorrador
HLED-115/AL	Aluminio	Muro	250 lm	4 W	100-240 V ~	3000 K	80	20 000 h	LED	25°	Driver LED	44	Ahorrador
HLED-116/AL	Aluminio	Muro	300 lm	6 W	100-240 V ~	3000 K	80	20 000 h	LED	25°	Driver LED	44	Ahorrador
HLED-402/7.5W/30/B	Blanco	Muro	150 lm	7.5 W	100-240 V ~	3000 K	80	20 000 h	LED	160°	Driver LED	45	Ahorrador

*Tecnolite se reserva el derecho de modificar la información sin previo aviso y no se hace responsable por errores u omisiones en este documento.



HLED-210/7W/30/S
PRAVIA

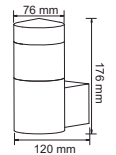

HLED-135/001/30/S
CUMBRES

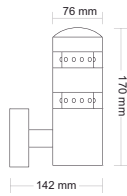

HLED-105/S
TORINO

HLED-200/6W/30
ZAPALA
B: BLANCO
G: GRIS

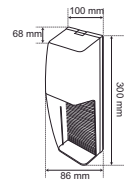

PRODUCTO	TERMINADO DEL PRODUCTO	APLICACIÓN	LÚMENES	POTENCIA	VOLTS	TEMPERATURA DE COLOR	IRC	TIEMPO DE VIDA	TIPO DE LÁMPARA	ÁNGULO	INCLUYE	IP	OBSERVACIONES
HLED-210/7W/30/S	Satinado	Muro	260 lm	7 W	100-240 V ~	3000 K	80	30 000 h	LED	120°	Driver LED	45	Ahorrador
HLED-135/001/30/S	Satinado	Muro	200 lm	4 W	100-127 V ~	3000 K	80	20 000 h	LED	97°	Driver LED	44	Ahorrador
HLED-105/S	Satinado	Muro	70 lm	3 W	100-127 V ~	3000 K	80	15 000 h	LED	15°	Driver LED	45	Ahorrador
HLED-200/6W/30/B	Blanco	Muro	300 lm	6 W	100-240 V ~	3000 K	80	20 000 h	LED	45°	Driver LED	45	Ahorrador
HLED-200/6W/30/G	Gris	Muro	300 lm	6 W	100-240 V ~	3000 K	80	20 000 h	LED	45°	Driver LED	45	Ahorrador

*Tecnolite se reserva el derecho de modificar la información sin previo aviso y no se hace responsable por errores u omisiones en este documento.

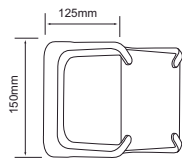

HLED-1201/G
KYBOX

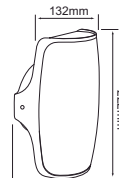

HLED-946/G
CORVUX

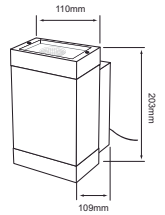
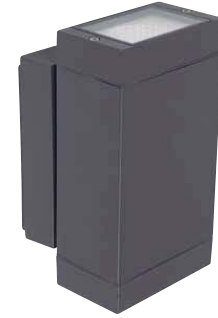

HLED-842/30/G
BETULA



HLED-843/30/G
ARBOREA

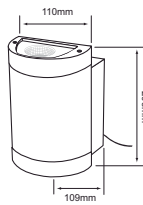

HLED-844/30/CR
EDULIS

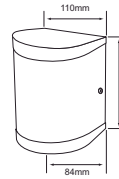

HLED-845/30/CR
FLAVUS

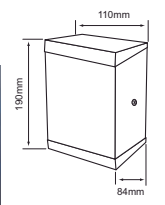

EXTERIOR / DECORATIVA / MUROS LED

PRODUCTO	TERMINADO DEL PRODUCTO	APLICACIÓN	LÚMENES	POTENCIA	VOLTS	TEMPERATURA DE COLOR	IRC	TIEMPO DE VIDA	TIPO DE LÁMPARA	ÁNGULO	INCLUYE	IP	OBSERVACIONES
HLED-1201/G	Gris	Muro	560 lm	11 W	100-240 V ~	3000 K	80	20 000 h	LED	155°	Driver LED	54	Ahorrador
HLED-946/G	Gris	Muro	470 lm	8 W	100-240 V ~	3000 K	80	20 000 h	LED	107°	Driver LED	54	Ahorrador
HLED-842/30/G	Gris	Muro	700 lm	14.5 W	100-240 V ~	3000 K	80	20 000 h	LED	31°	Driver LED	44	Ahorrador
HLED-843/30/G	Gris	Muro	700 lm	14.5 W	100-240 V ~	3000 K	80	20 000 h	LED	34°	Driver LED	44	Ahorrador
HLED-844/30/CR	Cromado	Muro	900 lm	14.5 W	100-240 V ~	3000 K	80	20 000 h	LED	180°	Driver LED	54	Ahorrador
HLED-845/30/CR	Cromado	Muro	900 lm	14.5 W	100-240 V ~	3000 K	80	20 000 h	LED	180°	Driver LED	54	Ahorrador

*Tecnolite se reserva el derecho de modificar la información sin previo aviso y no se hace responsable por errores u omisiones en este documento.

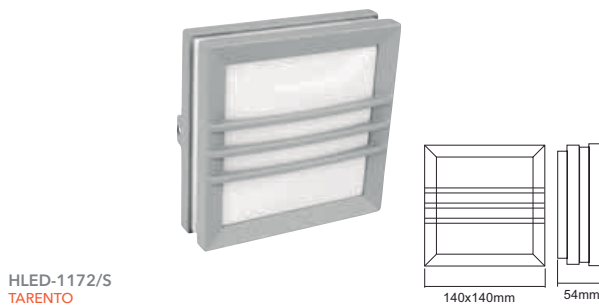
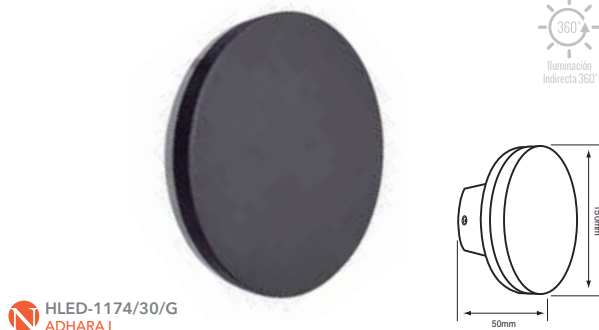

PRODUCTO	TERMINADO DEL PRODUCTO	APLICACIÓN	LÚMENES	POTENCIA	VOLTS	TEMPERATURA DE COLOR	IRC	TIEMPO DE VIDA	TIPO DE BASE	TIPO DE LÁMPARA	ÁNGULO	INCLUYE	IP	OBSERVACIONES
HLED-1174/30/G	Gris	Muro	700 lm	10 W	100-240 V ~	3000 K	80	15 000 h	LED	LED	106°	Driver LED	65	Ahorrador
HLED-1170/S	Satinado	Muro	240 lm	3 W	127 V ~	4000 K	80	15 000 h	GX53	GX53-LED/3W/40	180°	Lámpara autobalastada	45	Ahorrador
HLED-1172/S	Satinado	Muro	240 lm	3 W	127 V ~	4000 K	80	15 000 h	GX53	GX53-LED/3W/40	180°	Lámpara autobalastada	45	Ahorrador

*Tecnolite se reserva el derecho de modificar la información sin previo aviso y no se hace responsable por errores u omisiones en este documento.

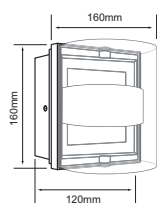

HLED-1050/N
TABRIZ

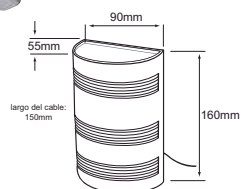

HLED-840
RAVENNE

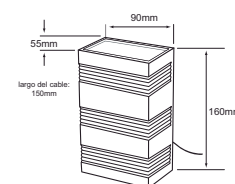

HLED-841
RAWENNA

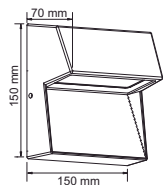
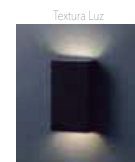
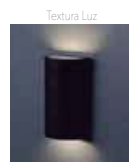

HLED-920/S
COPOS

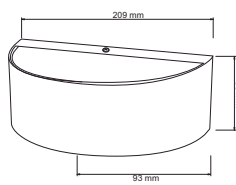

HLED-405/5W/40/S
ABUYA

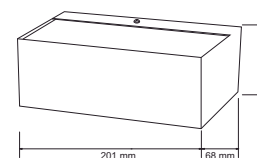

HLED-404/5W/40/S
ANDORRA



EXTERIOR / DECORATIVA / MUROS LED

PRODUCTO	TERMINADO DEL PRODUCTO	APLICACIÓN	LÚMENES	POTENCIA	VOLTS	TEMPERATURA DE COLOR	IRC	TIEMPO DE VIDA	TIPO DE LÁMPARA	ÁNGULO	INCLUYE	IP	OBSERVACIONES
HLED-1050/N	Negro	Muro	300 lm	9 W	100-240 V ~	4000 K	80	20 000 h	LED	120°	Driver LED	45	Ahorrador
HLED-840	Negro	Muro	300 lm	6 W	100-240 V ~	4000 K	80	15 000 h	LED	70°	Driver LED	55	Ahorrador
HLED-841	Negro	Muro	300 lm	6 W	100-240 V ~	4000 K	80	15 000 h	LED	70°	Driver LED	55	Ahorrador
HLED-920/S	Satinado	Muro	120 lm	3 W	100-240 V ~	3000 K	80	20 000 h	LED	44°	Driver LED	55	Ahorrador
HLED-405/5W/40/S	Satinado	Muro	180 lm	5 W	100-127 V ~	4000 K	80	20 000 h	LED	50°	Driver LED	45	Ahorrador
HLED-404/5W/40/S	Satinado	Muro	160 lm	5 W	100-127 V ~	4000 K	80	20 000 h	LED	50°	Driver LED	45	Ahorrador

*Tecnolite se reserva el derecho de modificar la información sin previo aviso y no se hace responsable por errores u omisiones en este documento.

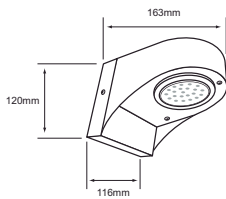

SLLED-11
VALETA

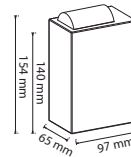

HLED-190/AN
CINTU

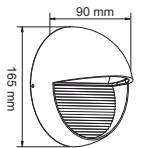
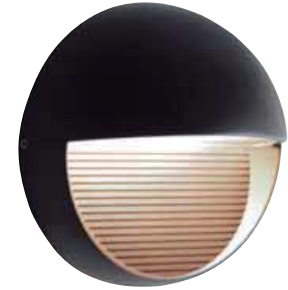

HLED-125/N
CRACOVIA

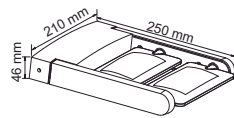

HLED-180/18W/S
CONTRA

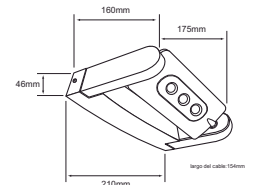

HLED-181/S
CONTRA I

PRODUCTO	TERMINADO DEL PRODUCTO	APLICACIÓN	LÚMENES	POTENCIA	VOLTS	TEMPERATURA DE COLOR	IRC	TIEMPO DE VIDA	TIPO DE BASE	TIPO DE LÁMPARA	ÁNGULO	INCLUYE	IP	OBSERVACIONES
SLLED-11	Negro	Muro	270 lm	3 W	127 V ~	4000K	80	15 000 h	GX53	GX53-LED/3W/40	110°	Lámpara autobalastada	45	Ahorrador
HLED-190/AN	Antracita	Muro	70 lm	6 W	100-127 V ~	3000 K	80	20 000 h	LED	LED	66°	Driver LED	65	Ahorrador
HLED-125/N	Negro	Muro	100 lm	3 W	100-240 V ~	3000 K	80	20 000 h	LED	LED	60°	Driver LED	45	Ahorrador
HLED-180/18W/S	Satinado	Muro	1 400 lm	15.5 W	100-240 V ~	3000 K	80	20 000 h	LED	LED	40°	Driver LED	65	Ahorrador. Dirigible
HLED-181/S	Satinado	Muro	700 lm	8.5 W	100-240 V ~	3000 K	80	20 000 h	LED	LED	40°	Driver LED	65	Ahorrador. Dirigible

*Tecnolite se reserva el derecho de modificar la información sin previo aviso y no se hace responsable por errores u omisiones en este documento.

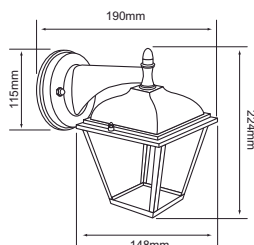

FTL-LED/007/30/N
HEDERA

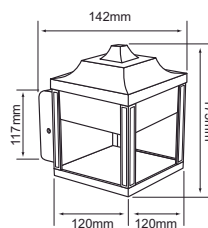

FTL-LED/008/30/N
OXALIS



EXTERIOR / DECORATIVA / MUROS LED

PRODUCTO	TERMINADO DEL PRODUCTO	PANTALLA	APLICACIÓN	LÚMENES	POTENCIA	VOLTS	TEMPERATURA DE COLOR	IRC	TIEMPO DE VIDA	TIPO DE LÁMPARA	ÁNGULO	INCLUYE	IP	OBSERVACIONES
FTL-LED/007/30/N	Negro	Cristal	Muro	400 lm	8.5 W	100-127 V ~	3000 K	80	20 000 h	LED	105°	Driver LED	44	Ahorrador
FTL-LED/008/30/N	Negro	Acrílico Opalino	Muro	330 lm	9 W	100-127 V ~	3000 K	80	20 000 h	LED	87°	Driver LED	44	Ahorrador

*Tecnolite se reserva el derecho de modificar la información sin previo aviso y no se hace responsable por errores u omisiones en este documento.

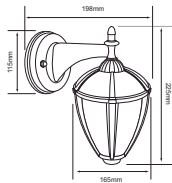

FTL-LED/001/N
RALEIGH

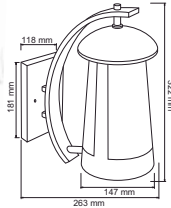

FTL-LED/002/11W/N
RABAT



FTL-LED/003/N
RANGÚN

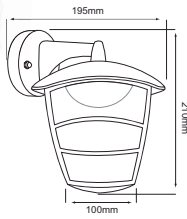

FTL-LED/004/N
RANGÚN I

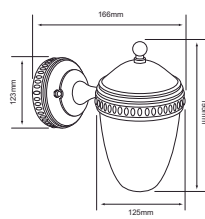

FTL-LED/005/N
ARNEB

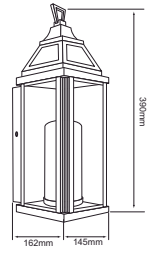

FTL-LED/006/N
VEGA

PRODUCTO	TERMINADO DEL PRODUCTO	PANTALLA	APLICACIÓN	LÚMENES	POTENCIA	VOLTS	TEMPERATURA DE COLOR	IRC	TIEMPO DE VIDA	TIPO DE LÁMPARA	ÁNGULO	INCLUYE	IP	OBSERVACIONES
FTL-LED/001/N	Negro	PC	Muro	300 lm	9 W	100-240 V ~	4000K	80	20 000 h	LED	156°	Driver LED	45	Ahorrador
FTL-LED/002/11W/N	Negro	Seedy	Muro	700 lm	11 W	100-127 V ~	4000K	80	30 000 h	LED	156°	Driver LED	45	Ahorrador
FTL-LED/003/N	Negro	PC	Muro	300 lm	9 W	100-240 V ~	4000K	80	20 000 h	LED	156°	Driver LED	45	Ahorrador
FTL-LED/004/N	Negro	PC	Muro	350 lm	10 W	100-240 V ~	4000K	80	20 000 h	LED	140°	Driver LED	44	Ahorrador
FTL-LED/005/N	Negro	Cristal	Muro	450 lm	8 W	100-127 V ~	3000K	80	20 000 h	LED	108°	Driver LED	54	Ahorrador
FTL-LED/006/N	Negro	Cristal	Muro	400 lm	13 W	127 V ~	3000K	80	20 000 h	LED	128°	Driver LED	44	Ahorrador

*Tecnolite se reserva el derecho de modificar la información sin previo aviso y no se hace responsable por errores u omisiones en este documento.

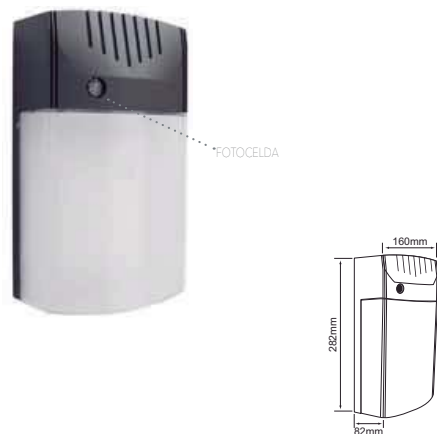

ESLED-4002/F
LUMUS



ST-LED/20W/40
BELEM I



ES-LED/501/G
ESTOCOLMO I



ES-LED/502/G
FOTON

PRODUCTO	TERMINADO DEL PRODUCTO	APLICACIÓN	LÚMENES	POTENCIA	VOLTS	TEMPERATURA DE COLOR	IRC	TIEMPO DE VIDA	TIPO DE LÁMPARA	ÁNGULO	INCLUYE	IP	OBSERVACIONES
ESLED-4002/F	Gris	Muro	3 900 lm	47 W	100-127 V ~	5000K	80	20 000 h	LED	59°	Driver LED	54	Ahorrador. Con fotocelda
ST-LED/20W/40	Negro	Muro	1 200 lm	20 W	100-240 V ~	4000K	80	20 000 h	LED	120°	Driver LED	65	Ahorrador
ES-LED/501/G	Gris	Muro	4 000 lm	50 W	100-127 V ~	6500 K	80	50 000 h	LED	120°	Driver LED	65	Ahorrador. Con fotocelda
ES-LED/502/G	Gris	Muro	2 200 lm	27 W	100-127 V ~	6500 K	80	20 000 h	LED	134°	Driver LED	44	Ahorrador

*Tecnolite se reserva el derecho de modificar la información sin previo aviso y no se hace responsable por errores u omisiones en este documento.

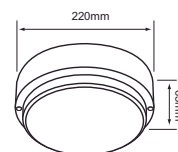

PTLLED-1110
LACERTA
40 B: BLANCO FRÍO
65 B: LUZ DE DÍA

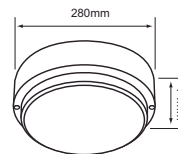

PTLLED-1120
LACERTA I
40 B: BLANCO FRÍO
65 B: LUZ DE DÍA

PRODUCTO	TERMINADO DEL PRODUCTO	APLICACIÓN	LÚMENES	POTENCIA	VOLTS	TEMPERATURA DE COLOR	IRC	TIEMPO DE VIDA	TIPO DE LÁMPARA	ÁNGULO	INCLUYE	IP	OBSERVACIONES
PTLLED-1110/40/B	Blanco	Sobreponer en techo	800 lm	9W	100-240 V ~	4000K	80	20 000 h	LED	115°	Driver LED	65	Ahorrador
PTLLED-1110/65/B	Blanco	Sobreponer en techo	800 lm	9W	100-240 V ~	6500 K	80	20 000 h	LED	115°	Driver LED	65	Ahorrador
PTLLED-1120/40/B	Blanco	Sobreponer en techo	1 500 lm	18W	100-240 V ~	4000K	80	20 000 h	LED	115°	Driver LED	65	Ahorrador
PTLLED-1120/65/B	Blanco	Sobreponer en techo	1 500 lm	18W	100-240 V ~	6500 K	80	20 000 h	LED	115°	Driver LED	65	Ahorrador

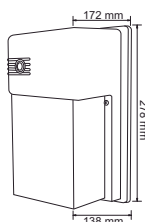

ES-4002/F
VERONA

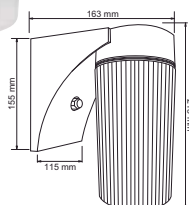

SL-20
VITORIO

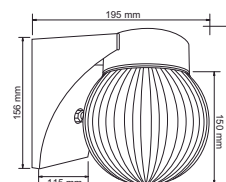

GL-20
VICENZA

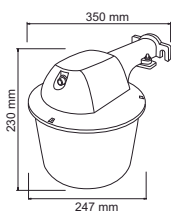

ES-6501/N
TAMPERÉ

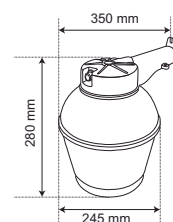

ES-6500-1
ESPEJO II

PRODUCTO	TERMINADO DEL PRODUCTO	APLICACIÓN	LÚMENES	POTENCIA	VOLTS	TEMPERATURA DE COLOR	IRC	TIEMPO DE VIDA	TIPO DE BASE	TIPO DE LÁMPARA	INCLUYE	IP	OBSERVACIONES
ES-4002/F	Café	Muro	1 800 lm	40 W	100-127 V ~	4100K	80	10 000 h	E27 x 2	2 x TE-20W/41	Lámpara	45	Ahorrador. Con fotocelda
SL-20	Café Oscuro	Muro	1 000 lm	20 W	100-127 V ~	4100K	80	10 000 h	E27	TE-20W/41	Lámpara	45	Ahorrador
GL-20	Café Oscuro	Muro	1 000 lm	20 W	100-127 V ~	4100K	80	10 000 h	E27	TE-20W/41	Lámpara	45	Ahorrador
ES-6501/N	Negro	Muro	4 400 lm	65 W	100-127 V ~	6500 K	80	10 000 h	E27	HEL-65W/65	Sí	43	Ahorrador. Con fotocelda
ES-6500-1	Gris	Muro	4 400 lm	65 W	100-127 V ~	6500 K	80	10 000 h	E27	HEL-65W/65	Sí	43	Ahorrador. Con fotocelda

*Tecnolite se reserva el derecho de modificar la información sin previo aviso y no se hace responsable por errores u omisiones en este documento.

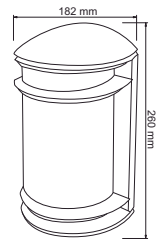

H-945
URBINO
B: BLANCO
S: SATINADO

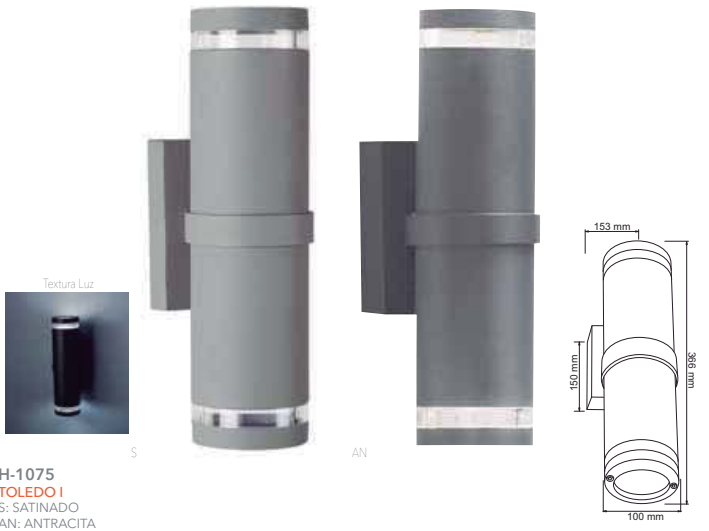

H-1075
TOLEDO I
S: SATINADO
AN: ANTRACITA

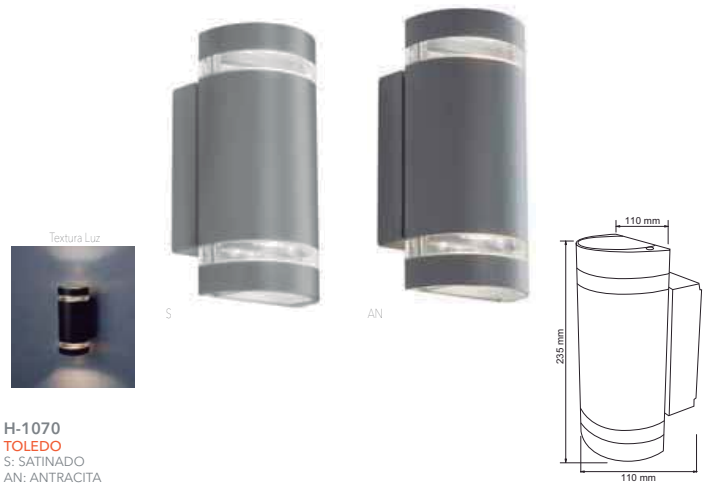

H-1070
TOLEDO
S: SATINADO
AN: ANTRACITA

PRODUCTO	TERMINADO DEL PRODUCTO	APLICACIÓN	POTENCIA	VOLTS	TIPO DE BASE	TIPO DE LÁMPARA	INCLUYE LÁMPARA	IP	OBSERVACIONES
H-945/B	Blanco	Muro	15 W	100-240 V ~	E27	Opcional	No	45	Se sugiere lámpara LED o ahorradora
H-945/S	Satinado	Muro	15 W	100-240 V ~	E27	Opcional	No	45	Se sugiere lámpara LED o ahorradora
H-1075/S	Satinado	Muro	40 W	100-240 V ~	E27 x 2	Opcional	No	45	Se sugiere lámpara LED o ahorradora
H-1075/AN	Antracita	Muro	40 W	100-240 V ~	E27 x 2	Opcional	No	45	Se sugiere lámpara LED o ahorradora
H-1070/S	Satinado	Muro	70 W	100-240 V ~	GU10 x 2	2 x GU10	No	45	Se sugiere lámpara LED o ahorradora
H-1070/AN	Antracita	Muro	70 W	100-240 V ~	GU10 x 2	2 x GU10	No	45	Se sugiere lámpara LED o ahorradora

*Tecnolite se reserva el derecho de modificar la información sin previo aviso y no se hace responsable por errores u omisiones en este documento.

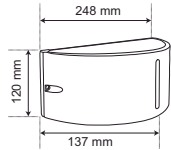

H-1151/AN
RAUCH

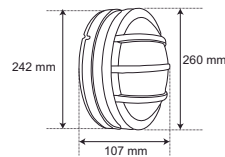

H-1155/S
TERUEL III

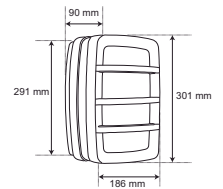

H-1153/S
TERUEL II

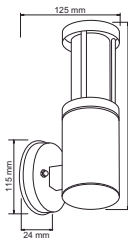

H-1180/S
CITRON

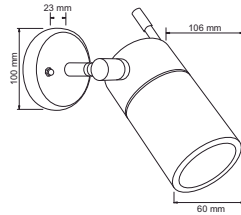

H-760/S
TALLIN

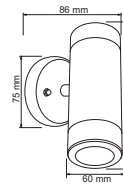

H-1105/S
TROPEA

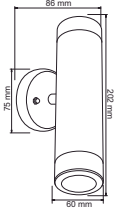

H-1106/S
TROPEA I

PRODUCTO	TERMINADO DEL PRODUCTO	APLICACIÓN	POTENCIA	VOLTS	TIPO DE BASE	TIPO DE LÁMPARA	INCLUYE LÁMPARA	IP	OBSERVACIONES
H-1151/AN	Antracita	Muro	15 W	100-240 V ~	E27	Opcional	No	45	Se sugiere lámpara LED
H-1155/S	Satinado	Muro	15 W	100-240 V ~	E27	Opcional	No	45	Se sugiere lámpara LED
H-1153/S	Satinado	Muro	30 W	100-240 V ~	E27 x 2	Opcional	No	45	Se sugiere lámpara LED
H-1180/S	Satinado	Muro	15 W	100-240 V ~	E27	Opcional	No	45	Se sugiere lámpara LED
H-760/S	Satinado	Muro	35 W	100-240 V ~	GU10	GU10	No	45	Se sugiere lámpara LED
H-1105/S	Satinado	Muro	70 W	100-240 V ~	GU10 x 2	2 x GU10	No	45	Se sugiere lámpara LED
H-1106/S	Satinado	Muro	70 W	100-240 V ~	GU10 x 2	2 x GU10	No	45	Se sugiere lámpara LED

*Tecnolite se reserva el derecho de modificar la información sin previo aviso y no se hace responsable por errores u omisiones en este documento.

H-800
TURIN
 B: BLANCO
 S: SATINADO



B



S

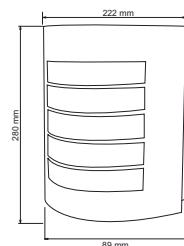

89 mm

H-810
TURIN I
 B: BLANCO
 S: SATINADO



B



S

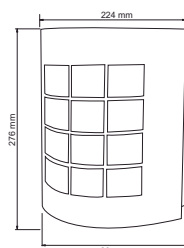

89 mm

H-815
TURIN II
 B: BLANCO
 S: SATINADO



B



S

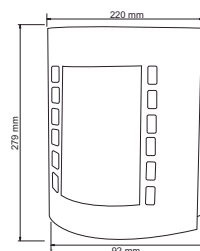

92 mm

PRODUCTO	TERMINADO DEL PRODUCTO	APLICACIÓN	POTENCIA	VOLTS	TIPO DE BASE	TIPO DE LÁMPARA	INCLUYE LÁMPARA	IP	OBSERVACIONES
H-800/B	Blanco	Muro	15 W	100-240 V ~	E27	Opcional	No	45	Se sugiere lámpara LED o ahorradora
H-800/S	Satinado	Muro	15 W	100-240 V ~	E27	Opcional	No	45	Se sugiere lámpara LED o ahorradora
H-810/B	Blanco	Muro	15 W	100-240 V ~	E27	Opcional	No	45	Se sugiere lámpara LED o ahorradora
H-810/S	Satinado	Muro	15 W	100-240 V ~	E27	Opcional	No	45	Se sugiere lámpara LED o ahorradora
H-815/B	Blanco	Muro	15 W	100-240 V ~	E27	Opcional	No	45	Se sugiere lámpara LED o ahorradora
H-815/S	Satinado	Muro	15 W	100-240 V ~	E27	Opcional	No	45	Se sugiere lámpara LED o ahorradora

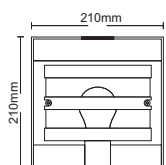

H-1060/S
TRENTO

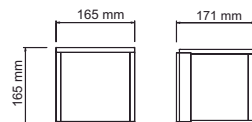

H-1200/S
TOULON

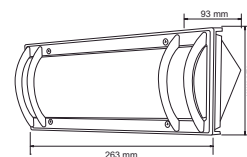

H-1090/B
TREZZA

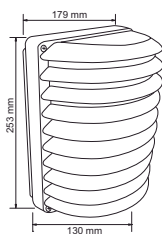

H-1130/S
TIRANA

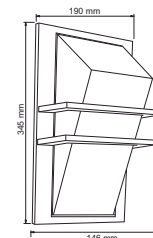

H-1190/S
TALIN

PRODUCTO	TERMINADO DEL PRODUCTO	APLICACIÓN	POTENCIA	VOLTS	TIPO DE BASE	TIPO DE LÁMPARA	INCLUYE LÁMPARA	IP	OBSERVACIONES
H-1060/S	Satinado	Muro	20 W	100-240 V ~	E27	Opcional	No	45	Se sugiere lámpara LED o ahorradora
H-1200/S	Satinado	Muro	15 W	100-240 V ~	E27	Opcional	No	45	Se sugiere lámpara LED o ahorradora
H-1090/B	Bianco	Muro	20 W	100-240 V ~	E27	Opcional	No	45	Se sugiere lámpara LED o ahorradora
H-1130/S	Satinado	Muro	15 W	100-240 V ~	E27	Opcional	No	45	Se sugiere lámpara LED o ahorradora
H-1190/S	Satinado	Muro	20 W	100-240 V ~	E27	Opcional	No	45	Se sugiere lámpara LED o ahorradora

*Tecnolite se reserva el derecho de modificar la información sin previo aviso y no se hace responsable por errores u omisiones en este documento.

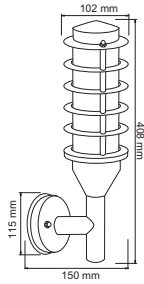

H-1085/S
TREVISO

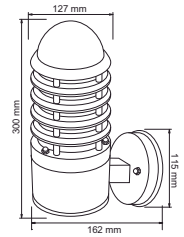

H-1110/S
URBIETO

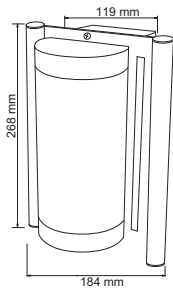

H-1030/S
VARESE

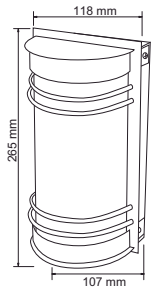

H-1050/S
VENEZIA

PRODUCTO	TERMINADO DEL PRODUCTO	APLICACIÓN	POTENCIA	VOLTS	TIPO DE BASE	TIPO DE LÁMPARA	INCLUYE LÁMPARA	IP	OBSERVACIONES
H-1085/S	Satinado	Muro	20 W	100-240 V ~	E27	Opcional	No	45	Se sugiere lámpara LED o ahorradora
H-1110/S	Satinado	Muro	20 W	100-240 V ~	E27	Opcional	No	45	Se sugiere lámpara LED o ahorradora
H-1030/S	Satinado	Muro	20 W	100-240 V ~	E27	Opcional	No	45	Se sugiere lámpara LED o ahorradora
H-1050/S	Satinado	Muro	20 W	100-240 V ~	E27	Opcional	No	45	Se sugiere lámpara LED o ahorradora

*Tecnolite se reserva el derecho de modificar la información sin previo aviso y no se hace responsable por errores u omisiones en este documento.

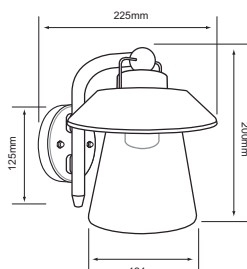

FTL-3423/BA
SPICA

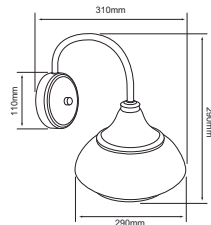

FTL-3425/BA
SADIRA

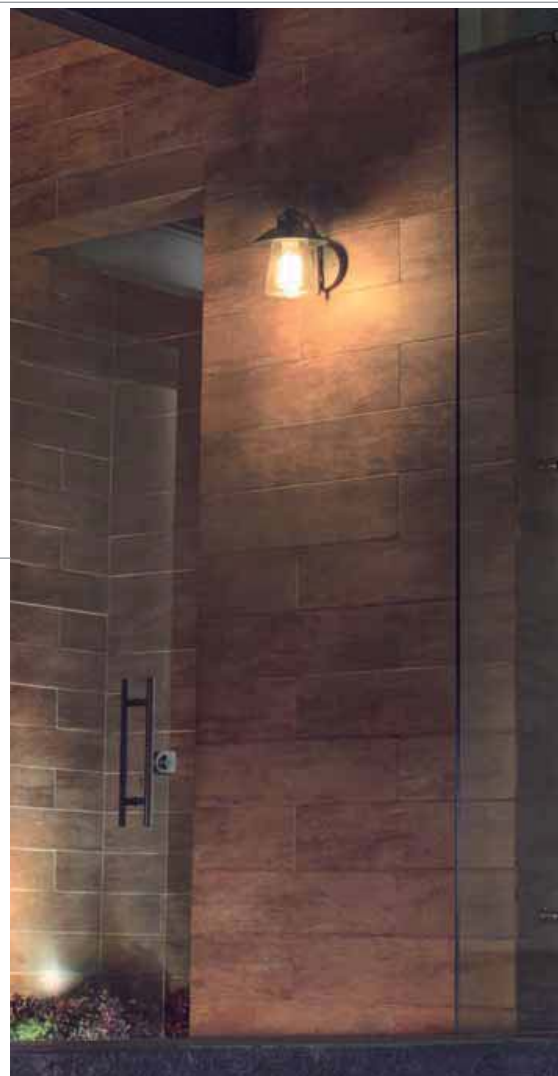

EXTERIOR / DECORATIVA / MUROS SIN LÁMPARA

PRODUCTO	TERMINADO DEL PRODUCTO	APLICACIÓN	POTENCIA	VOLTS	TIPO DE BASE	TIPO DE LÁMPARA	INCLUYE LÁMPARA	IP	OBSERVACIONES
FTL-3423/BA	Bronce antiguo	Muro	20 W	100-240 V ~	E27	Opcional	No	44	Se sugiere lámpara LED o ahorradora
FTL-3425/BA	Bronce antiguo	Muro	20 W	100-240 V ~	E27	Opcional	No	44	Se sugiere lámpara LED o ahorradora

*Tecnolite se reserva el derecho de modificar la información sin previo aviso y no se hace responsable por errores u omisiones en este documento.

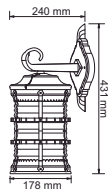

FTL-4110/BA
RUSO

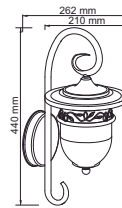

FTL-3330/BA
REVENNA

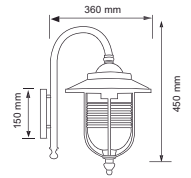

FTL-1402/BA
RIMNI

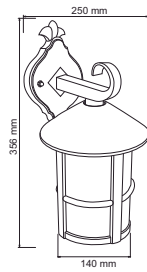

FTL-3340/BA
SARAJEVO

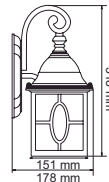

FTL-3420/S
POZNA

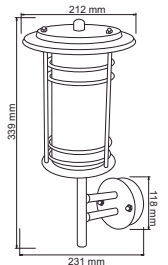

FTL-8250/S
SABARI

PRODUCTO	TERMINADO DEL PRODUCTO	APLICACIÓN	POTENCIA	VOLTS	TIPO DE BASE	TIPO DE LÁMPARA	INCLUYE LÁMPARA	IP	OBSERVACIONES
FTL-4110/BA	Bronce antiguo	Muro	20 W	100-240 V ~	E27	Opcional	No	44	Se sugiere lámpara LED o ahorradora
FTL-3330/BA	Bronce antiguo	Muro	20 W	100-240 V ~	E27	Opcional	No	44	Se sugiere lámpara LED o ahorradora
FTL-1402/BA	Bronce antiguo	Muro	26 W	100-240 V ~	E27	Opcional	No	44	Se sugiere lámpara LED o ahorradora
FTL-3340/BA	Bronce antiguo	Muro	26 W	100-240 V ~	E27	Opcional	No	44	Se sugiere lámpara LED o ahorradora
FTL-3420/S	Satinado	Muro	20 W	100-240 V ~	E27	Opcional	No	44	Se sugiere lámpara LED o ahorradora
FTL-8250/S	Satinado	Muro	20 W	100-240 V ~	E27	Opcional	No	44	Se sugiere lámpara LED o ahorradora

*Tecnolite se reserva el derecho de modificar la información sin previo aviso y no se hace responsable por errores u omisiones en este documento.

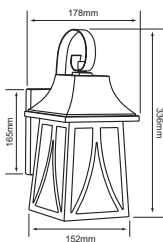

FTL-3421/N
ANTONELLA



EXTERIOR / DECORATIVA / MUROS SIN LÁMPARA



Ideal Zonas Costeras

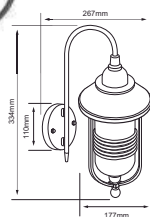

FTL-8202
BIXA
B: BLANCO
N: NEGRO

PRODUCTO	TERMINADO DEL PRODUCTO	APLICACIÓN	POTENCIA	VOLTS	TIPO DE BASE	TIPO DE LÁMPARA	INCLUYE LÁMPARA	IP	OBSERVACIONES
FTL-3421/N	Negro	Muro	26 W	100-240 V ~	E27	Opcional	No	44	Se sugiere lámpara LED o ahorradora
FTL-8202/B	Blanco	Muro	20 W	100-240 V ~	E27	Opcional	No	44	Se sugiere lámpara LED o ahorradora
FTL-8202/N	Negro	Muro	20 W	100-240 V ~	E27	Opcional	No	44	Se sugiere lámpara LED o ahorradora

*Tecnolite se reserva el derecho de modificar la información sin previo aviso y no se hace responsable por errores u omisiones en este documento.

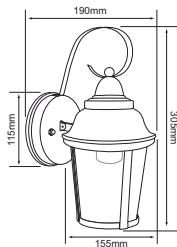

FTL-3422/N
ALLEGRA

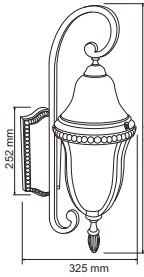

FTL-3000/BA
ROCCA

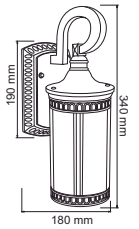

FTL-3200/BA
PETRA

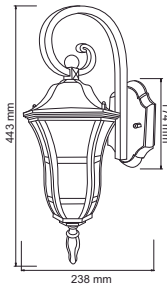

FTL-3800/BA
RONDA

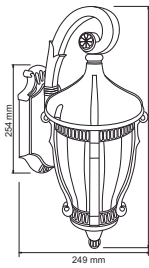

FTL-3300/BA
SEGOVIA

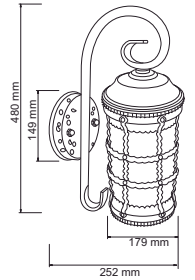

FTL-4100/BA
TERME

PRODUCTO	TERMINADO DEL PRODUCTO	APLICACIÓN	POTENCIA	VOLTS	TIPO DE BASE	TIPO DE LÁMPARA	INCLUYE LÁMPARA	IP	OBSERVACIONES
FTL-3422/N	Negro	Muro	26 W	100-240 V ~	E27	Opcional	No	44	Se sugiere lámpara LED o ahorradora
FTL-3000/BA	Bronce antiguo	Muro	26 W	100-240 V ~	E27	Opcional	No	44	Se sugiere lámpara LED o ahorradora
FTL-3200/BA	Bronce antiguo	Muro	26 W	100-240 V ~	E27	Opcional	No	44	Se sugiere lámpara LED o ahorradora
FTL-3800/BA	Bronce antiguo	Muro	26 W	100-240 V ~	E27	Opcional	No	44	Se sugiere lámpara LED o ahorradora
FTL-3300/BA	Bronce antiguo	Muro	20 W	100-240 V ~	E27	Opcional	No	44	Se sugiere lámpara LED o ahorradora
FTL-4100/BA	Bronce antiguo	Muro	26 W	100-240 V ~	E27	Opcional	No	44	Se sugiere lámpara LED o ahorradora

*Tecnolite se reserva el derecho de modificar la información sin previo aviso y no se hace responsable por errores u omisiones en este documento.

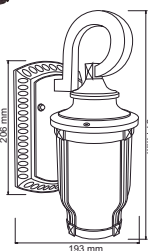

FTL-6000/BA
SABINO

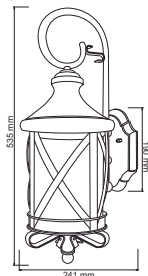

FTL-4000/BA
ROMA

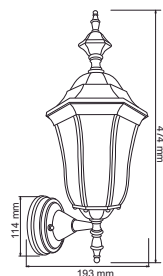

FTL-6005/BA
SAN JUAN

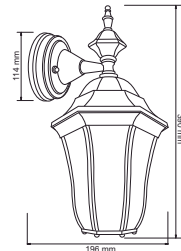

FTL-6005D/BA
SAN JUAN I



B



CF



N



V

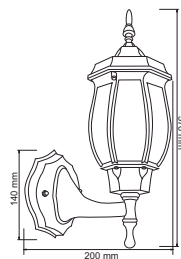

FTL-6002
SALERMO
B: BLANCO
CF: CAFÉ
N: NEGRO
V: VERDE

PRODUCTO	TERMINADO DEL PRODUCTO	APLICACIÓN	POTENCIA	VOLTS	TIPO DE BASE	TIPO DE LÁMPARA	INCLUYE LÁMPARA	IP	OBSERVACIONES
FTL-6000/BA	Bronce antiguo	Muro	13 W	100-240 V ~	E27	Opcional	No	44	Se sugiere lámpara LED o ahorradora
FTL-4000/BA	Bronce antiguo	Muro	26 W	100-240 V ~	E27 x 2	Opcional	No	44	Se sugiere lámpara LED o ahorradora
FTL-6005/BA	Bronce antiguo	Muro	26 W	100-240 V ~	E27	Opcional	No	44	Se sugiere lámpara LED o ahorradora
FTL-6005D/BA	Bronce antiguo	Muro	26 W	100-240 V ~	E27	Opcional	No	44	Se sugiere lámpara LED o ahorradora
FTL-6002/B	Blanco	Muro	20 W	100-240 V ~	E27	Opcional	No	44	Se sugiere lámpara LED o ahorradora
FTL-6002/CF	Café	Muro	20 W	100-240 V ~	E27	Opcional	No	44	Se sugiere lámpara LED o ahorradora
FTL-6002/N	Negro	Muro	20 W	100-240 V ~	E27	Opcional	No	44	Se sugiere lámpara LED o ahorradora
FTL-6002/V	Verde	Muro	20 W	100-240 V ~	E27	Opcional	No	44	Se sugiere lámpara LED o ahorradora

*Tecnolite se reserva el derecho de modificar la información sin previo aviso y no se hace responsable por errores u omisiones en este documento.

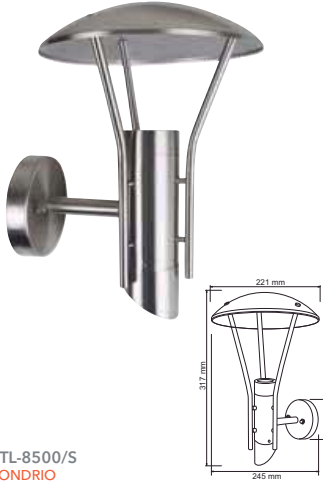

FTL-8500/S
SONDRIO



FTL-7355
SIENA
B: BLANCO
CF: CAFÉ
N: NEGRO

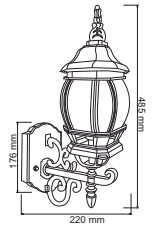

FTL-8200/S
SAVONA



FTL-6002D
SALERMO I
B: BLANCO
N: NEGRO



FTL-7055
SAN REMO
B: BLANCO
N: NEGRO

PRODUCTO	TERMINADO DEL PRODUCTO	APLICACIÓN	POTENCIA	VOLTS	TIPO DE BASE	TIPO DE LÁMPARA	INCLUYE LÁMPARA	IP	OBSERVACIONES
FTL-8500/S	Satinado	Muro	70 W	100-240 V ~	GU10 x 2	2 x GU10	No	44	Se sugiere lámpara LED o ahorradora
FTL-7355/B	Blanco	Muro	26 W	100-240 V ~	E27	Opcional	No	44	Se sugiere lámpara LED o ahorradora
FTL-7355/CF	Café	Muro	26 W	100-240 V ~	E27	Opcional	No	44	Se sugiere lámpara LED o ahorradora
FTL-7355/N	Negro	Muro	26 W	100-240 V ~	E27	Opcional	No	44	Se sugiere lámpara LED o ahorradora
FTL-8200/S	Satinado	Muro	26W	100-240 V ~	E-27	Opcional	No	44	Se sugiere lámpara LED o ahorradora
FTL-6002D/B	Blanco	Muro	26 W	100-240 V ~	E27	Opcional	No	44	Se sugiere lámpara LED o ahorradora
FTL-6002D/N	Negro	Muro	26 W	100-240 V ~	E27	Opcional	No	44	Se sugiere lámpara LED o ahorradora
FTL-7055/B	Blanco	Muro	26 W	100-240 V ~	E27	Opcional	No	44	Se sugiere lámpara LED o ahorradora
FTL-7055/N	Negro	Muro	26 W	100-240 V ~	E27	Opcional	No	44	Se sugiere lámpara LED o ahorradora

*Tecnolite se reserva el derecho de modificar la información sin previo aviso y no se hace responsable por errores u omisiones en este documento.

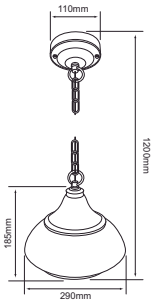

Lámpara Filamento
Vintage recomendada



FTL-3426/BA
GIEDI



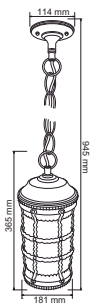

FTL-4001/BA
ROMA II



FTL-4101/BA
TERME I

EXTERIOR / SUSPENDIDOS / SIN LÁMPARA

PRODUCTO	TERMINADO DEL PRODUCTO	APLICACIÓN	POTENCIA	VOLTS	TIPO DE BASE	TIPO DE LÁMPARA	INCLUYE LÁMPARA	IP	OBSERVACIONES
FTL-3426/BA	Bronce Antiguo	Suspendido	20W	100-240 V ~	E27	 Opcional	No	44	Se sugiere lámpara LED o ahorradora
FTL-4001/BA	Bronce antiguo	Suspendido	52 W	100-240 V ~	E27 x 2	 Opcional	No	44	Se sugiere lámpara LED o ahorradora
FTL-4101/BA	Bronce antiguo	Suspendido	26 W	100-240 V ~	E27	 Opcional	No	44	Se sugiere lámpara LED o ahorradora

*Tecnolite se reserva el derecho de modificar la información sin previo aviso y no se hace responsable por errores u omisiones en este documento.

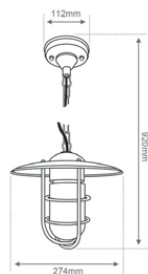

FTL-8201/ACI
SAVONA I

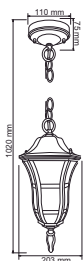

FTL-3801/BA
RONDA I

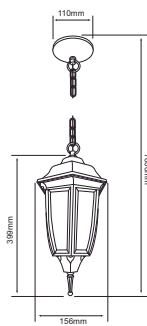

FTL-6003/N
SANTIAGO



B



CF



N

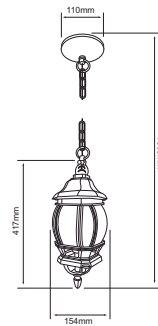

FTL-7356
SIENA II
B: BLANCO
CF: CAFÉ
N: NEGRO

PRODUCTO	TERMINADO DEL PRODUCTO	APLICACIÓN	POTENCIA	VOLTS	TIPO DE BASE	TIPO DE LÁMPARA	INCLUYE LÁMPARA	IP	OBSERVACIONES
FTL-8201/ACI	Satinado	Suspendido	60 W	100-240 V ~	E27	Opcional	No	44	Se sugiere lámpara LED o ahorradora
FTL-3801/BA	Bronce antiguo	Suspendido	26 W	100-240 V ~	E27	Opcional	No	44	Se sugiere lámpara LED o ahorradora
FTL-6003/N	Negro	Suspendido	26 W	100-240 V ~	E27	Opcional	No	44	Se sugiere lámpara LED o ahorradora
FTL-7356/B	Blanco	Suspendido	26 W	100-240 V ~	E27	Opcional	No	44	Se sugiere lámpara LED o ahorradora
FTL-7356/CF	Café	Suspendido	26 W	100-240 V ~	E27	Opcional	No	44	Se sugiere lámpara LED o ahorradora
FTL-7356/N	Negro	Suspendido	26 W	100-240 V ~	E27	Opcional	No	44	Se sugiere lámpara LED o ahorradora

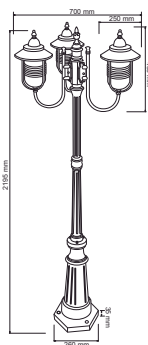

PFT-1402-3/BA
RIMINI I



PFT-6004-3
BADALONA
N: NEGRO
CF: CAFÉ

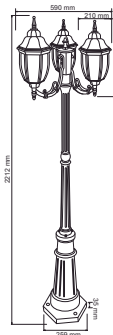

CF



PFT-7355-3
BELAGUA
N: NEGRO
CF: CAFÉ

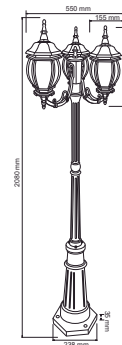

CF

PRODUCTO	TERMINADO DEL PRODUCTO	APLICACIÓN	POTENCIA	VOLTS	TIPO DE BASE	TIPO DE LÁMPARA	INCLUYE LÁMPARA	IP	OBSERVACIONES
PFT-1402-3/BA	Bronce antiguo	Sobreponer en piso	78 W	100-240 V ~	E27 x 3	Opcional	No	45	Se sugiere lámpara LED o ahorradora
PFT-6004-3/N	Negro	Sobreponer en piso	78 W	100-240 V ~	E27 x 3	Opcional	No	45	Se sugiere lámpara LED o ahorradora
PFT-6004-3/CF	Café	Sobreponer en piso	78 W	100-240 V ~	E27 x 3	Opcional	No	45	Se sugiere lámpara LED o ahorradora
PFT-7355-3/N	Negro	Sobreponer en piso	78 W	100-240 V ~	E27 x 3	Opcional	No	45	Se sugiere lámpara LED o ahorradora
PFT-7355-3/CF	Café	Sobreponer en piso	78 W	100-240 V ~	E27 x 3	Opcional	No	45	Se sugiere lámpara LED o ahorradora

*Tecnolite se reserva el derecho de modificar la información sin previo aviso y no se hace responsable por errores u omisiones en este documento.

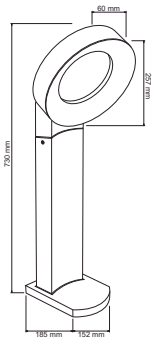

HLED-411/20W/40
AACHEN I

PRODUCTO	TERMINADO DEL PRODUCTO	APLICACIÓN	LÚMENES	POTENCIA	VOLTS	TEMPERATURA DE COLOR	IRC	TIEMPO DE VIDA	TIPO DE LÁMPARA	ÁNGULO	INCLUYE	IP	OBSERVACIONES
HLED-411/20W/40	Gris	Sobreponer en piso	1 400 lm	20 W	100-127 V ~	4000K	80	30 000 h	LED	120°	Driver LED	65	Ahorrador

*Tecnolite se reserva el derecho de modificar la información sin previo aviso y no se hace responsable por errores u omisiones en este documento.



EXTERIOR / DECORATIVA / MINI POSTES LED



HLED-412/30
MERIDIA

HLED-1175/30/G
ADHARA II

PRODUCTO	TERMINADO DEL PRODUCTO	APLICACIÓN	LÚMENES	POTENCIA	VOLTS	TEMPERATURA DE COLOR	IRC	TIEMPO DE VIDA	TIPO DE LÁMPARA	ÁNGULO	INCLUYE	IP	OBSERVACIONES
HLED-412/30	Gris	Sobreponer en piso	400 lm	6.5 W	100-240 V ~	3000 K	80	20 000 h	LED	110°	Driver LED	44	Ahorrador
HLED-1175/30/G	Gris	sobreponer en piso	700 lm	10 W	100-240 V ~	3000 K	80	15 000 h	LED	106°	Driver LED	65	Ahorrador

*Tecnolite se reserva el derecho de modificar la información sin previo aviso y no se hace responsable por errores u omisiones en este documento.

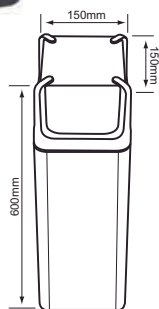

HLED-1202/G
CETUS

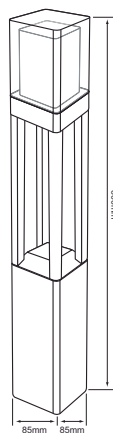

HLED-001/N/30
OBELIX I

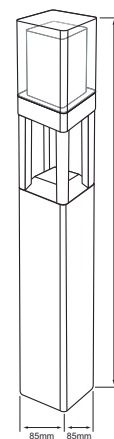

HLED-002/N/30
OBELIX II



PRODUCTO	TERMINADO DEL PRODUCTO	APLICACIÓN	LÚMENES	POTENCIA	VOLTS	TEMPERATURA DE COLOR	IRC	TIEMPO DE VIDA	TIPO DE LÁMPARA	ÁNGULO	INCLUYE	IP	OBSERVACIONES
HLED-1202/G	Gris	Sobreponer en piso	500 lm	11 W	100-240 V ~	3000 K	80	20 000 h	LED	155°	Driver LED	54	Ahorrador
HLED-001/N/30	Negro	Sobreponer en piso	635 lm	13 W	100-240 V ~	3000 K	80	30 000 h	LED	120°	Driver LED	65	Ahorrador
HLED-002/N/30	Negro	Sobreponer en piso	495 lm	13 W	100-240 V ~	3000 K	80	30 000 h	LED	120°	Driver LED	65	Ahorrador

*Tecnolite se reserva el derecho de modificar la información sin previo aviso y no se hace responsable por errores u omisiones en este documento.



HLED-003/N/30
OBELIX III

HLED-004/N/30
OBELIX IV

HLED-130/001/30/S
CUMBRES I

EXTERIOR / DECORATIVA / MINI POSTES LED



HLED-204/7W/30/S
ALORA I

HLED-205/7W/30/S
ALORA

HLED-100/S
ALMERIA

PRODUCTO	TERMINADO DEL PRODUCTO	APLICACIÓN	LÚMENES	POTENCIA	VOLTS	TEMPERATURA DE COLOR	IRC	TIEMPO DE VIDA	TIPO DE LÁMPARA	ÁNGULO	INCLUYE	IP	OBSERVACIONES
HLED-003/N/30	Negro	Sobreponer en piso	770 lm	13 W	100-240 V ~	3000 K	80	30 000 h	LED	120°	Driver LED	65	Ahorrador
HLED-004/N/30	Negro	Sobreponer en piso	810 lm	13 W	100-240 V ~	3000 K	80	30 000 h	LED	120°	Driver LED	65	Ahorrador
HLED-130/001/30/S	Satinado	Sobreponer en piso	60 lm	2.5 W	100-127 V ~	3000 K	80	20 000 h	LED	97°	Driver LED	44	Ahorrador
HLED-204/7W/30/S	Satinado	Sobreponer en piso	260 lm	7 W	100-240 V ~	3000 K	80	30 000 h	LED	120°	Driver LED	45	Ahorrador
HLED-205/7W/30/S	Satinado	Sobreponer en piso	260 lm	7 W	100-240 V ~	3000 K	80	30 000 h	LED	120°	Driver LED	45	Ahorrador
HLED-100/S	Satinado	Sobreponer en piso	70 lm	3 W	100-127 V ~	3000 K	80	15 000 h	LED	15°	Driver LED	65	Ahorrador

*Tecnolite se reserva el derecho de modificar la información sin previo aviso y no se hace responsable por errores u omisiones en este documento.



Lámpara Filamento
Vintage recomendada

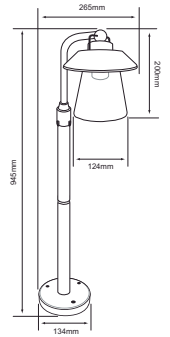

H-3423/BA
SPICA II

PRODUCTO	TERMINADO DEL PRODUCTO	APLICACIÓN	POTENCIA	VOLTS	TIPO DE BASE	TIPO DE LÁMPARA	INCLUYE LÁMPARA	IP	OBSERVACIONES
H-3423/BA	Bronce Antiguo	Sobreponer en piso	20 W	100-240 V ~	E27	Opcional	No	44	Se sugiere lámpara LED o ahorradora

*Tecnolite se reserva el derecho de modificar la información sin previo aviso y no se hace responsable por errores u omisiones en este documento.



EXTERIOR / DECORATIVA / MINI POSTES SIN LÁMPARA

H-414/S
ANKARA

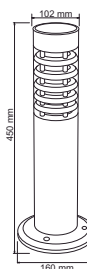

H-425/S
ALPINO

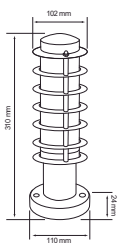

H-430/S
AMSTERDAM

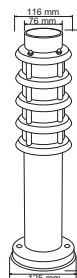

PRODUCTO	TERMINADO DEL PRODUCTO	APLICACIÓN	POTENCIA	VOLTS	TIPO DE BASE	TIPO DE LÁMPARA	INCLUYE LÁMPARA	IP	OBSERVACIONES
H-414/S	Satinado	Sobreponer en piso	20 W	100-240 V ~	E27	Opcional	No	45	Se sugiere lámpara LED o ahorradora
H-425/S	Satinado	Sobreponer en piso	20 W	100-240 V ~	E27	Opcional	No	45	Se sugiere lámpara LED o ahorradora
H-430/S	Satinado	Sobreponer en piso	20 W	100-240 V ~	E27	Opcional	No	45	Se sugiere lámpara LED o ahorradora

*Tecnolite se reserva el derecho de modificar la información sin previo aviso y no se hace responsable por errores u omisiones en este documento.

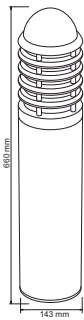

H-410/CR
ALMODOVAR



H-411/S
ALMODOVAR I

H-418/S
ALMATY

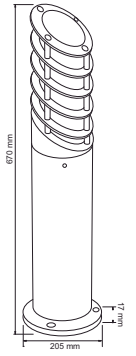
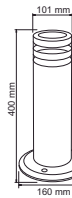

H-450/S
ALTAMIRA

PRODUCTO	TERMINADO DEL PRODUCTO	APLICACIÓN	POTENCIA	VOLTS	TIPO DE BASE	TIPO DE LÁMPARA	INCLUYE LÁMPARA	IP	OBSERVACIONES
H-410/CR	Cromado	Sobreponer en piso	15 W	100-240 V ~	E27	Opcional	No	44	Se sugiere lámpara LED o ahorradora
H-411/S	Satinado	Sobreponer en piso	15 W	100-240 V ~	E27	Opcional	No	45	Se sugiere lámpara LED o ahorradora
H-418/S	Satinado	Sobreponer en piso	20 W	100-240 V ~	E27	Opcional	No	45	Se sugiere lámpara LED o ahorradora
H-450/S	Satinado	Sobreponer en piso	23 W	100-240 V ~	E27	Opcional	No	67	Se sugiere lámpara LED o ahorradora

*Tecnolite se reserva el derecho de modificar la información sin previo aviso y no se hace responsable por errores u omisiones en este documento.



N



S

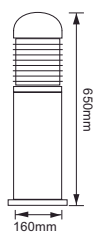

H-410
ALMODOVAR
N: NEGRO
S: SATINADO



CF



V

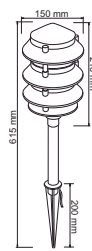

H-820
ANTEQUERA
CF: CAFÉ
VE: VERDE

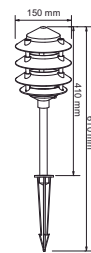

HFV-820/N
ANTEQUERA I

PRODUCTO	TERMINADO DEL PRODUCTO	APLICACIÓN	POTENCIA	VOLTS	TIPO DE BASE	TIPO DE LÁMPARA	INCLUYE LÁMPARA	IP	OBSERVACIONES
H-410/N	Negro	Sobreponer en piso	15 W	100-240 V ~	E27	Opcional	No	45	Se sugiere lámpara LED o ahorradora
H-410/S	Gris	Sobreponer en piso	15 W	100-240 V ~	E27	Opcional	No	45	Se sugiere lámpara LED o ahorradora
H-820/CF	Café	Luminario con estaca	13 W	100-240 V ~	E27	Opcional	No	45	Se sugiere lámpara ahorradora
H-820/V	Verde	Luminario con estaca	13 W	100-240 V ~	E27	Opcional	No	45	Se sugiere lámpara ahorradora
HFV-820/N	Negro	Luminario con estaca	13 W	100-240 V ~	E27	Opcional	No	45	Se sugiere lámpara ahorradora

*Tecnolite se reserva el derecho de modificar la información sin previo aviso y no se hace responsable por errores u omisiones en este documento.

ACENTO VIVE LA LUZ CON ACENTOS

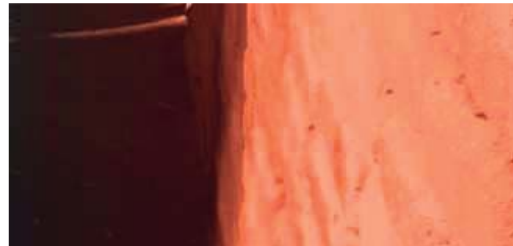

QUE **DESTACAN** CADA
DETALLE DE TUS **EXTERIORES**

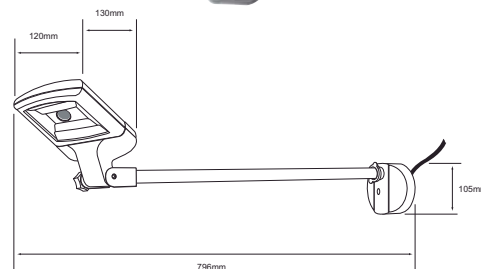

ES-LED/530/40
PORT LOUIS

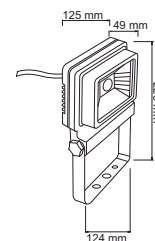

ES-LED/510/11W/40
BELMOPAN



PRODUCTO	TERMINADO DEL PRODUCTO	APLICACIÓN	LÚMENES	POTENCIA	VOLTS	TEMPERATURA DE COLOR	IRC	TIEMPO DE VIDA	TIPO DE LÁMPARA	ÁNGULO	INCLUYE	IP	OBSERVACIONES
ES-LED/530/40	Gris	Muro	800 lm	11 W	100-127 V ~	4000K	80	20 000 h	LED	105°	Driver LED	65	Ahorrador
ES-LED/510/11W/40	Gris	Muro	800 lm	11 W	100-127 V ~	4000K	80	30 000 h	LED	120°	Driver LED	45	Ahorrador

*Tecnolite se reserva el derecho de modificar la información sin previo aviso y no se hace responsable por errores u omisiones en este documento.

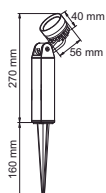

HLED-773/3W/30
BERAT

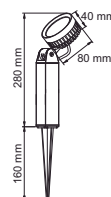
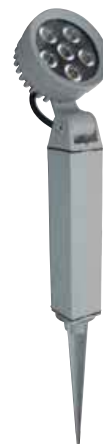

HLED-776/6W/30
BENDIN

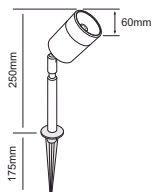

HLED-756/S
BURSERA

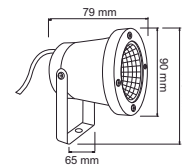

HLED-505/4W/CF
BEIJING

PRODUCTO	TERMINADO DEL PRODUCTO	APLICACIÓN	LÚMENES	POTENCIA	VOLTS	TEMPERATURA DE COLOR	IRC	TIEMPO DE VIDA	TIPO DE LÁMPARA	ÁNGULO	INCLUYE	IP	OBSERVACIONES
HLED-773/3W/30	Gris	Luminario con estaca	150 lm	3 W	100-240 V ~	3000 K	80	20 000 h	LED	25°	Driver LED	65	Ahorrador
HLED-776/6W/30	Gris	Luminario con estaca	350 lm	6 W	100-240 V ~	3000 K	80	20 000 h	LED	25°	Driver LED	65	Ahorrador
HLED-756/S	Satinado	Luminario con estaca	300 lm	4.5 W	100-127 V ~	3000 K	80	20 000 h	LED	49°	Driver LED	44	Ahorrador
HLED-505/4W/CF	Café	Sobreponer en piso	200 lm	4 W	100-240 V ~	3000 K	80	20 000 h	LED	60°	Driver LED	45	Ahorrador



EXTERIOR / ACENTO / LED

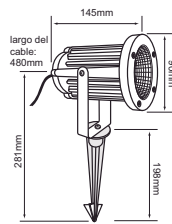

HLED-755/N
BILBAU I

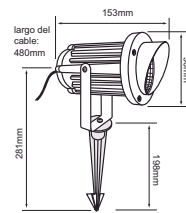

HLED-760/N
BILBAU II

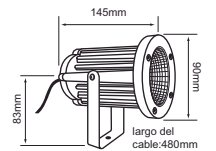

HLED-750/N
BILBAU

PRODUCTO	TERMINADO DEL PRODUCTO	APLICACIÓN	LÚMENES	POTENCIA	VOLTS	TEMPERATURA DE COLOR	IRC	TIEMPO DE VIDA	TIPO DE LÁMPARA	ÁNGULO	INCLUYE	IP	OBSERVACIONES
HLED-755/N	Negro	Luminario con estaca	500 lm	8 W	100-240 V ~	4000 K	70	15 000 h	LED	40°	Driver LED	65	Ahorrador
HLED-760/N	Negro	Luminario con estaca	500 lm	8 W	100-240 V ~	4000 K	70	15 000 h	LED	40°	Driver LED	65	Ahorrador
HLED-750/N	Negro	Sobreponer en piso	500 lm	8 W	100-240 V ~	4000 K	70	15 000 h	LED	40°	Driver LED	65	Ahorrador

*Tecnolite se reserva el derecho de modificar la información sin previo aviso y no se hace responsable por errores u omisiones en este documento.

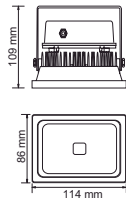

LQ-LED/10W
BASEL
30 S: BLANCO CÁLIDO
65 S: LUZ DE DÍA

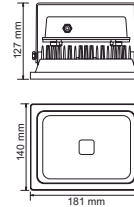

LQ-LED/20W
BASEL I
30 S: BLANCO CÁLIDO
65 S: LUZ DE DÍA

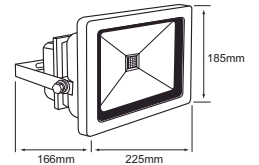

LQ-LED/30W
BASEL II
30 S: BLANCO CÁLIDO
65 S: LUZ DE DÍA

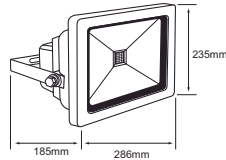

LQ-LED/50W/30/S
BASEL III
30 S: BLANCO CÁLIDO
65 S: LUZ DE DÍA

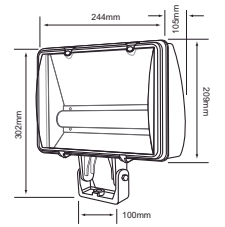

ES-LED/3600
BOLONIA I



PRODUCTO	TERMINADO DEL PRODUCTO	APLICACIÓN	LÚMENES	POTENCIA	VOLTS	TEMPERATURA DE COLOR	IRC	TIEMPO DE VIDA	TIPO DE LÁMPARA	ÁNGULO	INCLUYE	IP	OBSERVACIONES
LQ-LED/10W/30/S	Satinado	Sobreponer en piso o muro	700 lm	10 W	100-240 V ~	3000 K	70	35 000 h	LED	120°	Driver LED	65	Ahorrador
LQ-LED/10W/65/S	Satinado	Sobreponer en piso o muro	700 lm	10 W	100-240 V ~	6500 K	70	35 000 h	LED	120°	Driver LED	65	Ahorrador
LQ-LED/20W/30/S	Satinado	Sobreponer en piso o muro	1 500 lm	20 W	100-240 V ~	3000 K	70	35 000 h	LED	120°	Driver LED	65	Ahorrador
LQ-LED/20W/65/S	Satinado	Sobreponer en piso o muro	1 500 lm	20 W	100-240 V ~	6500 K	70	35 000 h	LED	120°	Driver LED	65	Ahorrador
LQ-LED/30W/30/S	Satinado	Sobreponer en piso o muro	1 800 lm	30 W	100-240 V ~	3000 K	70	35 000 h	LED	120°	Driver LED	65	Ahorrador
LQ-LED/30W/65/S	Satinado	Sobreponer en piso o muro	2 050 lm	30 W	100-240 V ~	6500 K	70	35 000 h	LED	120°	Driver LED	65	Ahorrador
LQ-LED/50W/30/S	Satinado	Sobreponer en piso o muro	3 000 lm	50 W	100-240 V ~	3000 K	70	35 000 h	LED	120°	Driver LED	65	Ahorrador
LQ-LED/50W/65/S	Satinado	Sobreponer en piso o muro	3 000 lm	50 W	100-240 V ~	6500 K	70	35 000 h	LED	120°	Driver LED	65	Ahorrador
ES-LED/3600	Negro	Sobreponer en piso o muro	1 200 lm	15 W	100-240 V ~	6500 K	80	25 000 h	LED	110°	Driver LED	65	Ahorrador

*Tecnolite se reserva el derecho de modificar la información sin previo aviso y no se hace responsable por errores u omisiones en este documento.

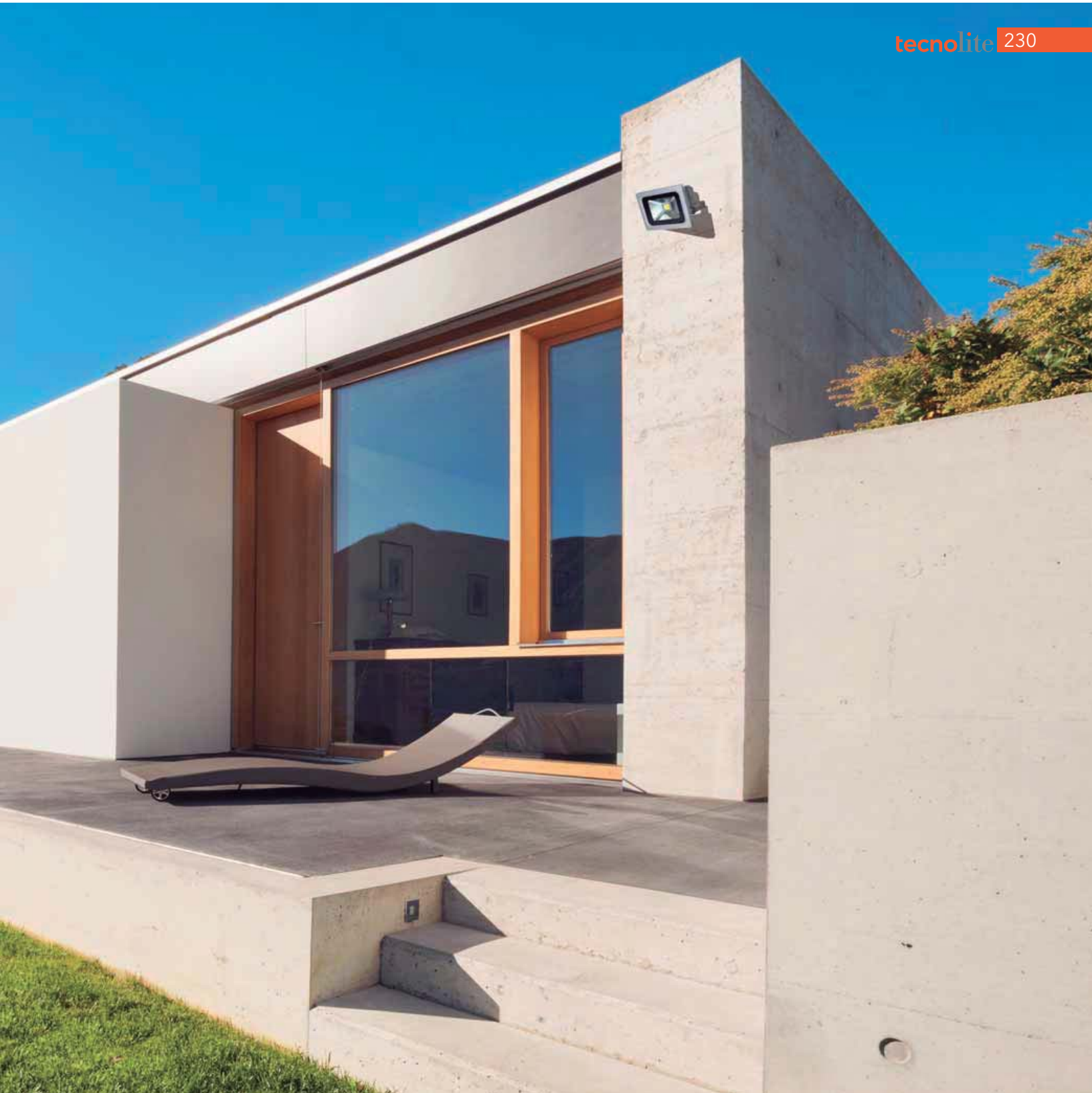

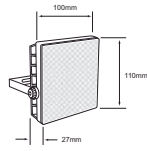

LQ-LED/001
LUMIERE I
30: BLANCO CÁLIDO
65: LUZ DE DÍA
AM: AMBAR

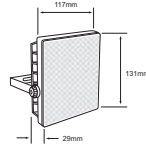

LQ-LED/002
LUMIERE II
30: BLANCO CÁLIDO
65: LUZ DE DÍA

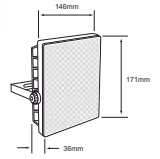

LQ-LED/003
LUMIERE III
30: BLANCO CÁLIDO
65: LUZ DE DÍA

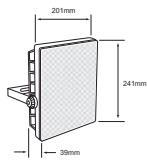

LQ-LED/004
LUMIERE IV
30: BLANCO CÁLIDO
65: LUZ DE DÍA
AM: AMBAR

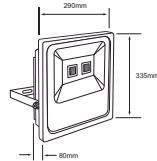

LQ-LED/005
LUMIERE V
30: BLANCO CÁLIDO
65: LUZ DE DÍA

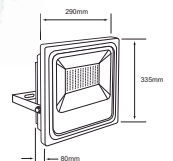

LQ-LED/006
LUMIERE VI
30: BLANCO CÁLIDO
65: LUZ DE DÍA

PRODUCTO	TERMINADO DEL PRODUCTO	APLICACIÓN	LÚMENES	POTENCIA	VOLTS	TEMPERATURA DE COLOR	IRC	TIEMPO DE VIDA	TIPO DE LÁMPARA	ÁNGULO	INCLUYE	IP	OBSERVACIONES
LQ-LED/001/30	Negro	Sobreponer en piso o muro	800 lm	10 W	100-240 V ~	3000 K	80	25 000 h	LED	90°	Driver LED	65	Ahorrador
LQ-LED/001/65	Negro	Sobreponer en piso o muro	800 lm	10 W	100-240 V ~	6500 K	80	25 000 h	LED	90°	Driver LED	65	Ahorrador
LQ-LED/001/AM	Negro	Sobreponer en piso o muro	600 lm	10 W	100-240 V ~		80	25 000 h	LED	90°	Driver LED	65	Ahorrador
LQ-LED/002/30	Negro	Sobreponer en piso o muro	1 600 lm	20 W	100-240 V ~	3000 K	80	25 000 h	LED	90°	Driver LED	65	Ahorrador
LQ-LED/002/65	Negro	Sobreponer en piso o muro	1 600 lm	20 W	100-240 V ~	6500 K	80	25 000 h	LED	90°	Driver LED	65	Ahorrador
LQ-LED/003/30	Negro	Sobreponer en piso o muro	2 400 lm	30 W	100-240 V ~	3000 K	80	25 000 h	LED	90°	Driver LED	65	Ahorrador
LQ-LED/003/65	Negro	Sobreponer en piso o muro	2 400 lm	30 W	100-240 V ~	6500 K	80	25 000 h	LED	90°	Driver LED	65	Ahorrador
LQ-LED/004/30	Negro	Sobreponer en piso o muro	4 000 lm	50 W	100-240 V ~	3000 K	80	25 000 h	LED	90°	Driver LED	65	Ahorrador
LQ-LED/004/65	Negro	Sobreponer en piso o muro	4 000 lm	50 W	100-240 V ~	6500 K	80	25 000 h	LED	90°	Driver LED	65	Ahorrador
LQ-LED/004/AM	Negro	Sobreponer en piso o muro	3 000 lm	50 W	100-240 V ~		80	25 000 h	LED	90°	Driver LED	65	Ahorrador
LQ-LED/005/30	Negro	Sobreponer en piso o muro	5 600 lm	70 W	100-240 V ~	3000 K	70	20 000 h	LED	90°	Driver LED	65	Ahorrador
LQ-LED/005/65	Negro	Sobreponer en piso o muro	5 600 lm	70 W	100-240 V ~	6500 K	70	20 000 h	LED	90°	Driver LED	65	Ahorrador
LQ-LED/006/30	Negro	Sobreponer en piso o muro	7 000 lm	100 W	100-240 V ~	3000 K	70	20 000 h	LED	90°	Driver LED	65	Ahorrador
LQ-LED/006/65	Negro	Sobreponer en piso o muro	7 000 lm	100 W	100-240 V ~	6500 K	70	20 000 h	LED	90°	Driver LED	65	Ahorrador

*Tecnolite se reserva el derecho de modificar la información sin previo aviso y no se hace responsable por errores u omisiones en este documento.

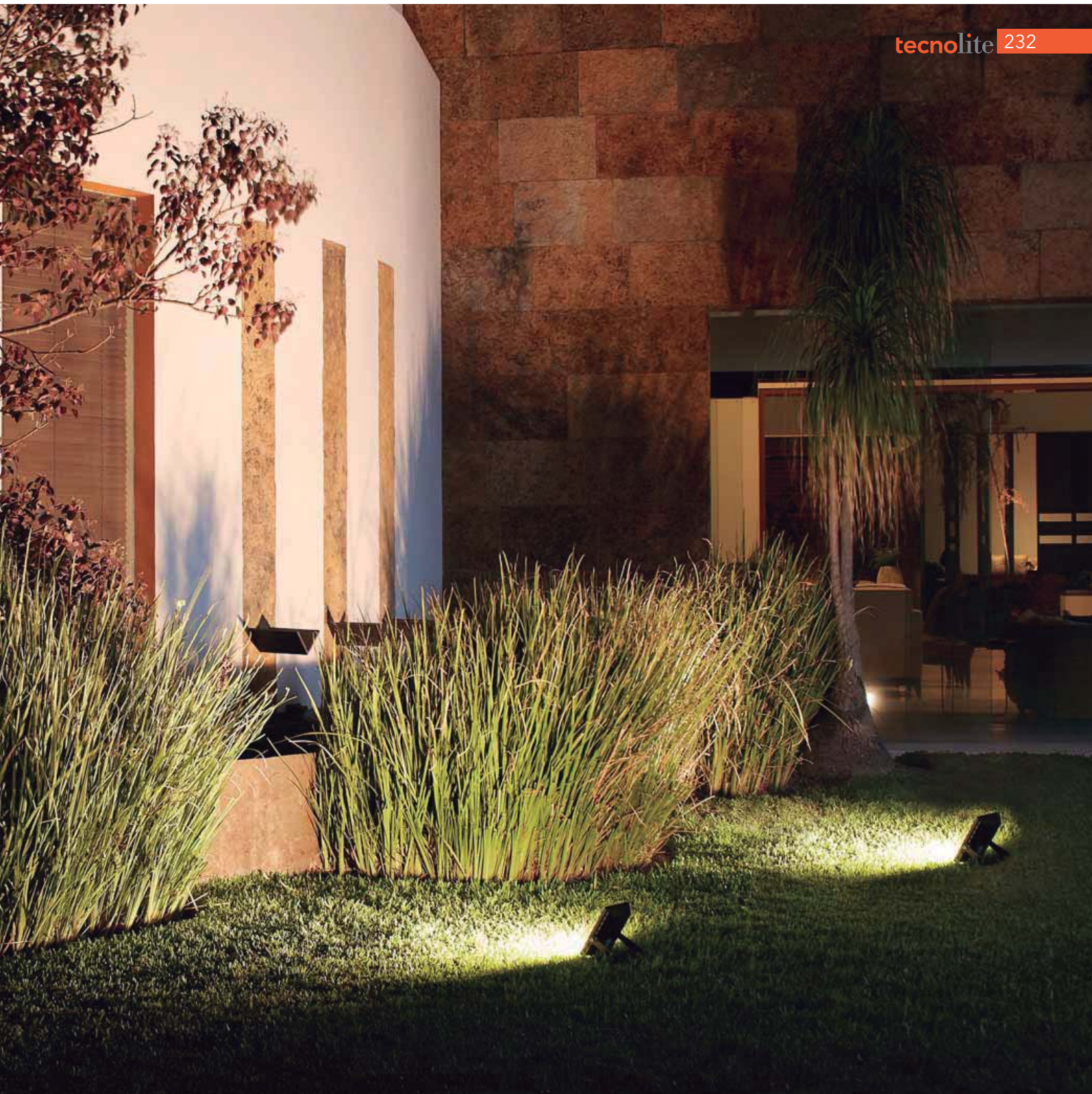

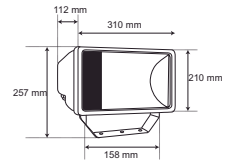

ES-6530
VARO



PRODUCTO	TERMINADO DEL PRODUCTO	APLICACIÓN	LÚMENES	POTENCIA	VOLTS	TEMPERATURA DE COLOR	IRC	TIEMPO DE VIDA	TIPO DE BASE	TIPO DE LÁMPARA	INCLUYE	IP	OBSERVACIONES
ES-6530	Negro	Sobreponer en piso o muro	4 400 lm	65 W	100-127 V ~	6500 K	80	10 000 h	E27	HEL-65W	Lámpara	65	Ahorrador

*Tecnolite se reserva el derecho de modificar la información sin previo aviso y no se hace responsable por errores u omisiones en este documento.

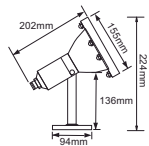

H-730/S
BIHOR I

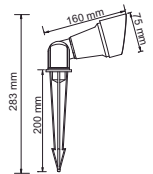

HFV-750-V/N
BILBAO III

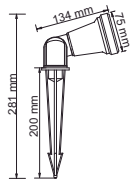

HFV-750/N
BILBAO IV

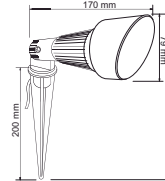

H-750-V/N
BILBAO I

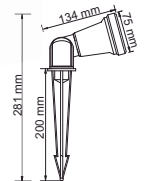

H-750/V
BILBAO

PRODUCTO	TERMINADO DEL PRODUCTO	APLICACIÓN	POTENCIA	VOLTS	TIPO DE BASE	TIPO DE LÁMPARA	INCLUYE LÁMPARA	IP	OBSERVACIONES
H-730/S	Satinado	Sobreponer en piso	90 W	100-240 V ~	E27	PAR38	No	65	Lámpara PAR fluorescente y LED disponible
HFV-750-V/N	Negro	Luminario con estaca	7 W	100-240 V ~	GX5.3	MR16-LED	No	45	Se sugiere usar lámpara LED de 7 W.
HFV-750/N	Negro	Luminario con estaca	7 W	100-240 V ~	GX5.3	MR16-LED	No	45	Se sugiere usar lámpara LED de 7 W.
H-750-V/N	Negro	Luminario con estaca	50 W	100-240 V ~ / 12 V ~	GX5.3	EXN	No	45	Lámpara a 12 V requiere transformador
H-750/V	Verde	Luminario con estaca	50 W	100-240 V ~ / 12 V ~	GX5.3	EXN	No	45	Lámpara a 12 V requiere transformador

*Tecnolite se reserva el derecho de modificar la información sin previo aviso y no se hace responsable por errores u omisiones en este documento.

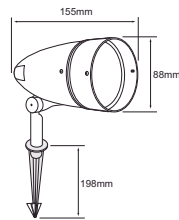

H-780/CF
BACO

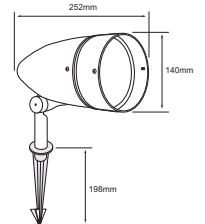

H-790/CF
BACO I

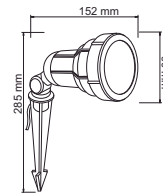

H-715/N
BILAR

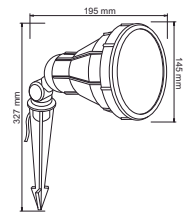

H-725/N
BILAR I

PRODUCTO	TERMINADO DEL PRODUCTO	APLICACIÓN	POTENCIA	VOLTS	TIPO DE BASE	TIPO DE LÁMPARA	INCLUYE LÁMPARA	IP	OBSERVACIONES
H-780/CF	Café	Luminario con estaca	50 W	100-240 V ~	E27	PAR20	No	45	Lámpara PAR fluorescente y LED disponible
H-790/CF	Café	Luminario con estaca	90 W	100-240 V ~	E27	PAR38	No	45	Lámpara PAR fluorescente
H-715/N	Negro	Luminario con estaca	50 W	100-240 V ~	E27	PAR20	No	65	Lámpara PAR fluorescente y LED disponible
H-725/N	Negro	Luminario con estaca	90 W	100-240 V ~	E27	PAR38	No	65	Lámpara PAR fluorescente

*Tecnolite se reserva el derecho de modificar la información sin previo aviso y no se hace responsable por errores u omisiones en este documento.

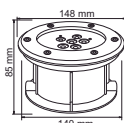

HLED-530/7.5WRGB
CHICAGO I

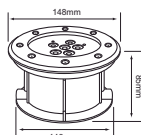

HLED-530/7.5W/30
CHICAGO



EXTERIOR / ACENTO / SUMERGIBLES FUENTES - ALBERCAS LED

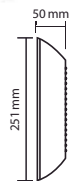

ALED-S56
ALED-S56/RGB
ATLANTIS I



ALED-P56
ALED-P56/RGB
ATLANTIS

PRODUCTO	TERMINADO DEL PRODUCTO	APLICACIÓN	LÚMENES	POTENCIA	VOLTS	TEMPERATURA DE COLOR	IRC	TIEMPO DE VIDA	TIPO DE LÁMPARA	ÁNGULO	INCLUYE	CORTE DE EMPOTRAMIENTO	IP	OBSERVACIONES
HLED-530/7.5WRGB	Satinado	Sumergible baja profundidad	-	7.5 W	100-240 V ~		-	30 000 h	LED	40°	Driver LED	140 mm	68	Ahorrador
HLED-530/7.5W/30	Satinado	Sumergible baja profundidad	350 lm	7.5 W	100-240 V ~	3000 K	80	30 000 h	LED	40°	Driver LED	140 mm	68	Ahorrador. Driver remoto
ALED-S56	Blanco	Sumergible alberca	1 000 lm	20 W	12 VCD	12 000 K	80	25 000 h	LED	120°	-	-	68	No se utilice fuera del agua. Reemplazo para luminario PAR56. Requiere driver
ALED-S56/RGB	Blanco	Sumergible alberca	-	15 W	12 VCD		-	25 000 h	LED	120°	-	-	68	No se utilice fuera del agua. Reemplazo para luminario PAR56. Requiere driver
ALED-P56	Blanco	Sumergible alberca	1 000 lm	20 W	12 VCD	12 000 K	80	25 000 h	LED	120°	-	180 mm	68	No se utilice fuera del agua. Reemplazo para luminario PAR56. Requiere driver
ALED-P56/RGB	Blanco	Sumergible alberca	-	15 W	12 VCD		-	25 000 h	LED	120°	-	180 mm	68	No se utilice fuera del agua. Reemplazo para luminario PAR56. Requiere driver

*Tecnolite se reserva el derecho de modificar la información sin previo aviso y no se hace responsable por errores u omisiones en este documento.



H-520/36W/CONTROL
CONTROLADOR PARA LUMINARIO

Secuencia de 7 colores y cambio de color cada 12 y 40 segs.
Soporta hasta 8 luminarios interconectados en 25 mts. máx.
Incluye control remoto.

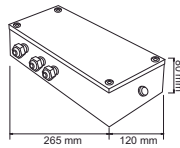

H-520/3W/30
DIJON

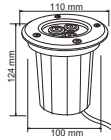

H-520/3W/RGB
DIJON

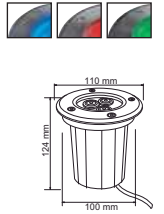

H-500/V
DENIA

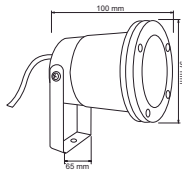

H-505/N
DENIA

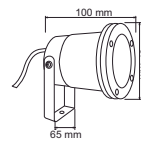

H-510/S
ESCALONA

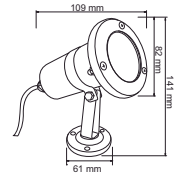

PRODUCTO	TERMINADO DEL PRODUCTO	APLICACIÓN	LÚMENES	POTENCIA	VOLTS	TEMPERATURA DE COLOR	IRC	TIEMPO DE VIDA	TIPO DE BASE	TIPO DE LÁMPARA	ÁNGULO	INCLUYE LÁMPARA	CORTE DE EMPOTRAMIENTO	IP	OBSERVACIONES
H-520/36W/CONTROL	Gris	-	-	36 W	100-127 V ~	-	-	-	-	-	-	-	-	-	Para uso exclusivo con H-520/3W/RGB
H-520/3W/30	Satinado	Sumergible baja profundidad	150 lm	3 W	12 V ~	3000 K	80	20 000 h	LED	LED	20°	Sí	100 mm	68	Sumersión máxima 1 m. Requiere driver.
H-520/3W/RGB	Satinado	Sumergible baja profundidad	-	3 W	12 V ~	RGB	-	20 000 h	LED	LED	20°	Sí	100 mm	68	Requiere controlador H-520/36W/CONTROL. Sumersión máxima 1 m.
H-500/V	Verde	Sumergible baja profundidad	330 lm	50 W	100-127 V ~ / 12 V ~	3000 K	80	2 000 h	GX5.3	EXN50W	38°	Sí	-	67	Lámpara a 12 V requiere transformador
H-505/N	Negro	Sumergible baja profundidad	330 lm	50 W	100-127 V ~ / 12 V ~	3000 K	80	2 000 h	GX5.3	EXN50W	38°	Sí	-	67	Lámpara a 12 V requiere transformador
H-510/S	Satinado	Sumergible baja profundidad	330 lm	50 W	100-127 V ~ / 12 V ~	3000 K	80	2 000 h	GX5.3	EXN50W	38°	Sí	-	68	Lámpara a 12 V requiere transformador

*Tecnolite se reserva el derecho de modificar la información sin previo aviso y no se hace responsable por errores u omisiones en este documento.

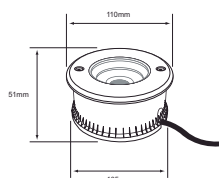

HLED-651/30
ORBIX

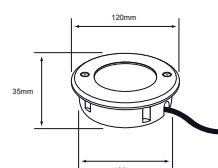

HLED-961/30
RUTA

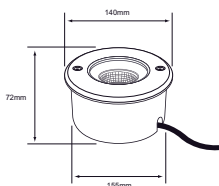

HLED-653/30
MOMO

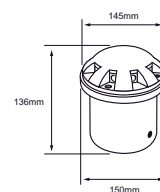

HLED-909/30
CEDRELA

PRODUCTO	TERMINADO DEL PRODUCTO	APLICACIÓN	LÚMENES	POTENCIA	VOLTS	TEMPERATURA DE COLOR	IRC	TIEMPO DE VIDA	TIPO DE LÁMPARA	ÁNGULO	INCLUYE	CORTE DE EMPOTRAMIENTO	IP	OBSERVACIONES
HLED-651/30	Satinado	Empotrado en piso	800 lm	10 W	100-127 V ~	3000 K	80	20 000 h	LED	79°	Driver LED	105 mm	67	Ahorrador
HLED-961/30	Satinado	Empotrado en piso	280 lm	9 W	100-127 V ~	3000 K	80	20 000 h	LED	90°	Driver LED	112 mm	67	Ahorrador
HLED-653/30	Satinado	Empotrado en piso	950 lm	14 W	100-127 V ~	3000 K	80	20 000 h	LED	42°	Driver LED	132 mm	67	Ahorrador
HLED-909/30	Gris	Empotrado en piso	400 lm	8 W	100-127 V ~	3000 K	80	20 000 h	LED	12°	Driver LED	115 mm	67	Ahorrador

*Tecnolite se reserva el derecho de modificar la información sin previo aviso y no se hace responsable por errores u omisiones en este documento.

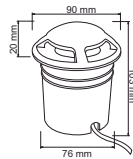

HLED-3W/S
CALGARY

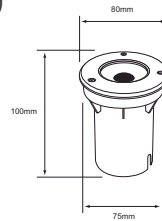

HLED-650/6W/30
CALICUT I

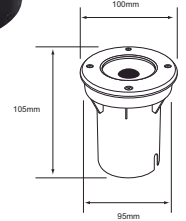

HLED-650/12W/30
CALICUT

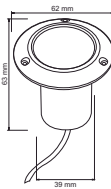

HLED-640/5W/S
ADANA

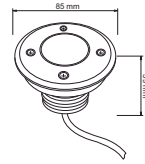

HLED-646/3W/S
AUCKLAND

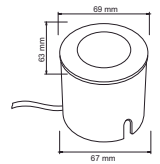

HLED-960/S
ANYAMA

PRODUCTO	TERMINADO DEL PRODUCTO	APLICACIÓN	LÚMENES	POTENCIA	VOLTS	TEMPERATURA DE COLOR	IRC	TIEMPO DE VIDA	TIPO DE LÁMPARA	ÁNGULO	INCLUYE	CORTE DE EMPOTRAMIENTO	IP	OBSERVACIONES
HLED-3W/S	Satinado	Empotrado en piso	6 lm	3 W	100-240 V ~	3000 K	80	25 000 h	LED	45°	Driver LED	76 mm	45	Ahorrador
HLED-650/6W/30	Aluminio	Empotrado en piso	400 lm	6 W	100-240 V ~	3000 K	80	25 000 h	LED	30°	Driver LED	75 mm	95	Ahorrador
HLED-650/12W/30	Aluminio	Empotrado en piso	800 lm	12 W	100-240 V ~	3000 K	80	25 000 h	LED	30°	Driver LED	95 mm	65	Ahorrador
HLED-640/5W/S	Satinado	Empotrado en piso	150 lm	5 W	100-240 V ~	3000 K	80	25 000 h	LED	45°	Driver LED	39 mm	65	Ahorrador
HLED-646/3W/S	Satinado	Empotrado en piso	60 lm	3 W	100-240 V ~	3000 K	80	20 000 h	LED	45°	Driver LED	80 mm	65	Ahorrador
HLED-960/S	Satinado	Empotrado en piso	10 lm	1.2 W	100-127 V ~	4000 K	80	20 000 h	LED	120°	Driver LED	67 mm	65	Ahorrador

*Tecnolite se reserva el derecho de modificar la información sin previo aviso y no se hace responsable por errores u omisiones en este documento.

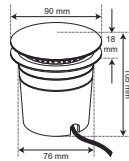

HLED-940/1W/30/S
CERES

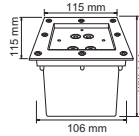

HLED-678/5W/30S
CAIRO

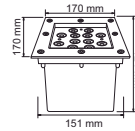

HLED-688/12W/30S
CAIRO I

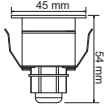

HLED-645/2W/S
BARATI

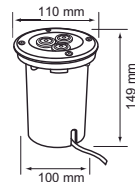

HLED-670/3W/30
CARCASONA

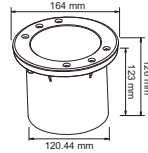

HLED-680/6W/30
CELLE



HLED-685/9W/30
CILLI

PRODUCTO	TERMINADO DEL PRODUCTO	APLICACIÓN	LÚMENES	POTENCIA	VOLTS	TEMPERATURA DE COLOR	IRC	TIEMPO DE VIDA	TIPO DE LÁMPARA	ÁNGULO	INCLUYE	CORTE DE EMPOTRAMIENTO	IP	OBSERVACIONES
HLED-940/1W/30/S	Gris	Empotrado en piso	50 lm	1 W	100-240 V ~	3000 K	80	15 000 h	LED	360°	Driver LED	76 mm	65	Ahorrador
HLED-678/5W/30S	Satinado	Empotrado en piso	200 lm	5 W	100-240 V ~	3000 K	80	20 000 h	LED	44°	Driver LED	106 mm x 106 mm	65	Ahorrador
HLED-688/12W/30S	Satinado	Empotrado en piso	650 lm	12 W	100-240 V ~	3000 K	80	20 000 h	LED	48°	Driver LED	151 mm x 151 mm	65	Ahorrador
HLED-645/2W/S	Satinado	Empotrado en piso	60 lm	2 W	100-240 V ~	3000 K	80	20 000 h	LED	20°	Driver LED	38 mm	65	Ahorrador
HLED-670/3W/30	Satinado	Empotrado en piso	160 lm	3 W	100-127 V ~	3000 K	80	20 000 h	LED	160°	Driver LED	100 mm	65	Ahorrador
HLED-680/6W/30	Satinado	Empotrado en piso	350 lm	6 W	100-240 V ~	3000 K	80	20 000 h	LED	160°	Driver LED	120 mm	65	Ahorrador
HLED-685/9W/30	Satinado	Empotrado en piso	400 lm	9 W	100-240 V ~	3000 K	80	20 000 h	LED	160°	Driver LED	120 mm	65	Ahorrador

*Tecnolite se reserva el derecho de modificar la información sin previo aviso y no se hace responsable por errores u omisiones en este documento.

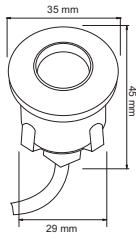

LEDK-600/CL
CATELLON

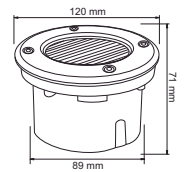

HLED-635/S
CASTI

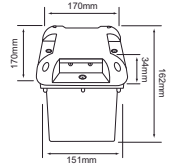

HLED-908/10W/30/S
CALI I

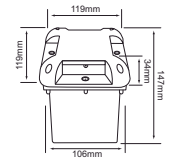

HLED-906/5W/30/S
CALI



PRODUCTO	TERMINADO DEL PRODUCTO	APLICACIÓN	LÚMENES	POTENCIA	VOLTS	TEMPERATURA DE COLOR	IRC	TIEMPO DE VIDA	TIPO DE BASE	TIPO DE LÁMPARA	ÁNGULO	INCLUYE	CORTE DE EMPOTRAMIENTO	IP	OBSERVACIONES
LEDK-600/CL	Acero inoxidable	Empotrado en piso	70 lm	4 W	12 V ~	3000 K	80	20 000 h	LED	LED	120°	Driver LED	29 mm	67	Ahorrador. Kit de 6 pzs. Incluye transformador
HLED-635/S	Satinado	Empotrado en piso	270 lm	3 W	127 V ~	4000 K	80	15 000 h	GX53	GX53-LED	110°	Lámpara autobalastada	89 mm	65	Ahorrador
HLED-908/10W/30/S	Satinado	Empotrado en piso	150 lm	10 W	100-240 V ~	3000 K	80	35 000 h	LED	LED	44°	Driver LED	151 mm x 151 mm	65	Ahorrador
HLED-906/5W/30/S	Satinado	Empotrado en piso	100 lm	5 W	100-240 V ~	3000 K	80	35 000 h	LED	LED	44°	Driver LED	106 mm x 106 mm	65	Ahorrador

*Tecnolite se reserva el derecho de modificar la información sin previo aviso y no se hace responsable por errores u omisiones en este documento.



H-600/S
COIMBRA

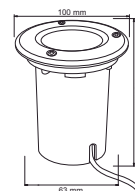

EXTERIOR / ACENTO / EMPOTRADOS LED



H-651/S
DAROCA I

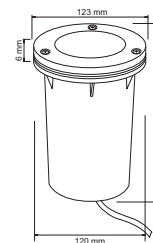

PRODUCTO	TERMINADO DEL PRODUCTO	APLICACIÓN	POTENCIA	VOLTS	TIPO DE BASE	TIPO DE LÁMPARA	INCLUYE LÁMPARA	CORTE DE EMPOTRAMIENTO	IP	OBSERVACIONES
H-600/S	Satinado	Empotrado en piso	50 W	100-240 V ~ / 12 V ~	GX5.3 / GU10	MR16/GU10	No	64 mm	65	Lámpara a 12 V requiere transformador
H-651/S	Satinado	Empotrado en piso	50 W	100-240 V ~ / 12 V ~	GX5.3 / GU10	MR16/GU10	No	120 mm	65	Lámpara a 12 V requiere transformador. Dirigible.

*Tecnolite se reserva el derecho de modificar la información sin previo aviso y no se hace responsable por errores u omisiones en este documento.

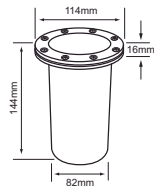

H-605/S
CONSTANZA I

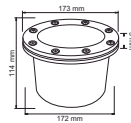

H-615/S
CUENCA II

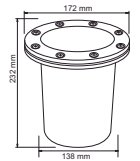

H-625/S
CUENCA III

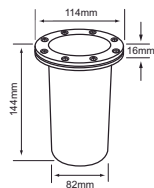

H-605/N
CONSTANZA

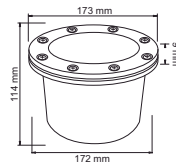

H-615/N
CUENCA

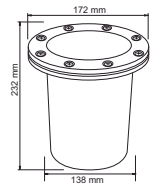

H-625/N
CUENCA I



PRODUCTO	TERMINADO DEL PRODUCTO	APLICACIÓN	POTENCIA	VOLTS	TIPO DE BASE	TIPO DE LÁMPARA	INCLUYE LÁMPARA	CORTE DE EMPOTRAMIENTO	IP	OBSERVACIONES
H-605/S	Satinado	Empotrado en piso	50 W	100-240 V ~	E27	PAR20	No	116 mm	65	Lámpara PAR fluorescente y LED disponible
H-615/S	Satinado	Empotrado en piso	50 W	100-240 V ~ / 12 V ~	G53	AR-111	No	172 mm	65	No usar con lámparas LED mayor a 11 W. Lámpara a 12 V requiere driver
H-625/S	Satinado	Empotrado en piso	90 W	100-240 V ~	E27	PAR38	No	138 mm	65	Lámpara PAR fluorescente
H-605/N	Negro	Empotrado en piso	50 W	100-240 V ~	E27	PAR20	No	116 mm	65	Lámpara PAR fluorescente y LED disponible
H-615/N	Negro	Empotrado en piso	50 W	100-240 V ~ / 12 V ~	G53	AR-111	No	172 mm	65	No usar con lámparas LED mayor a 11 W. Lámpara a 12 V requiere driver
H-625/N	Negro	Empotrado en piso	90 W	100-240 V ~	E27	PAR38	No	138 mm	65	Lámpara PAR fluorescente

*Tecnolite se reserva el derecho de modificar la información sin previo aviso y no se hace responsable por errores u omisiones en este documento.



Ideal Zonas Costeras

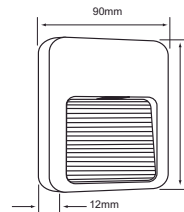

HLED-903/B AVIOR



LED

360°
Iluminación Indirecta 360°

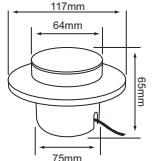

HLED-941/30/B ESFERIS

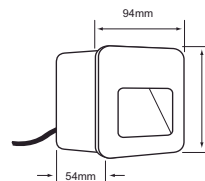

HLED-907/30/G BHARANI

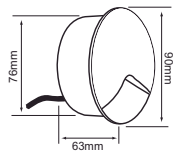

HLED-916/30/G CETI

PRODUCTO	TERMINADO DEL PRODUCTO	APLICACIÓN	LÚMENES	POTENCIA	VOLTS	TEMPERATURA DE COLOR	IRC	TIEMPO DE VIDA	TIPO DE LÁMPARA	ÁNGULO	INCLUYE	IP	OBSERVACIONES
HLED-903/B	Blanco	Muro	60 lm	1.5 W	100-240 V ~	3000 K	80	15 000 h	LED	50°	Driver LED	65	Ahorrador
HLED-941/30/B	Blanco	Muro o Piso	120 lm	6 W	100-240 V ~	3000 K	80	15 000 h	LED	152°	Driver LED	65	Ahorrador
HLED-907/30/G	Gris	Muro	50 lm	2 W	100-127 V ~	3000 K	80	20 000 h	LED	29°	Driver LED	54	Ahorrador
HLED-916/30/G	Gris	Muro	35 lm	2.5 W	100-127 V ~	3000 K	80	20 000 h	LED	29°	Driver LED	54	Ahorrador

*Tecnolite se reserva el derecho de modificar la información sin previo aviso y no se hace responsable por errores u omisiones en este documento.

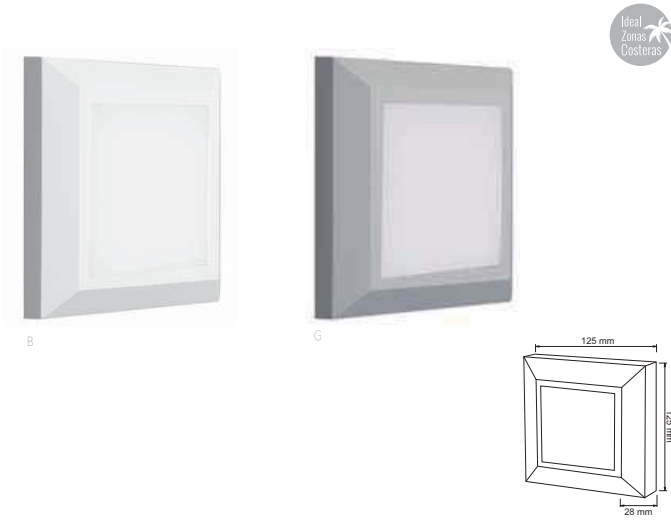

HLED-802
ANSHAN III
B: BLANCO
G: GRIS

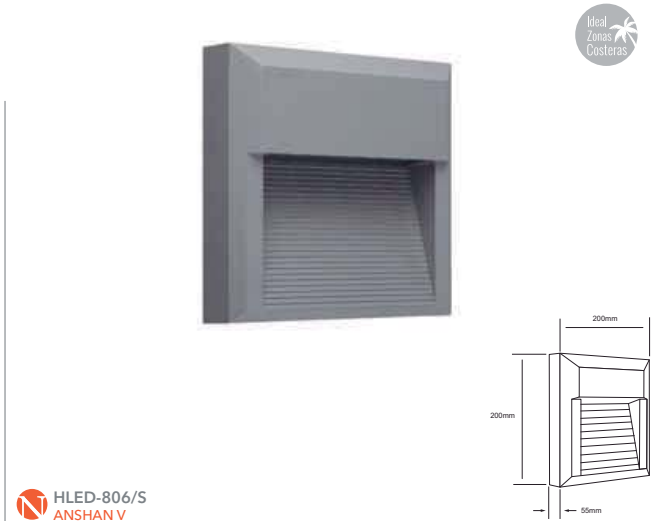

HLED-806/S
ANSHAN V

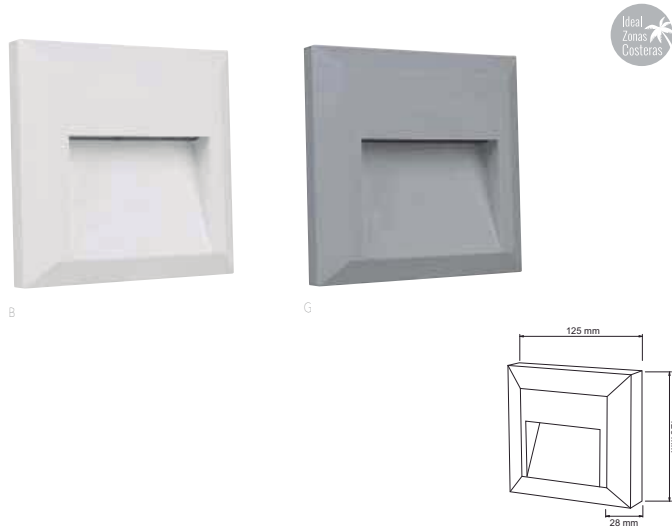

HLED-803
ANSHAN I
B: BLANCO
G: GRIS

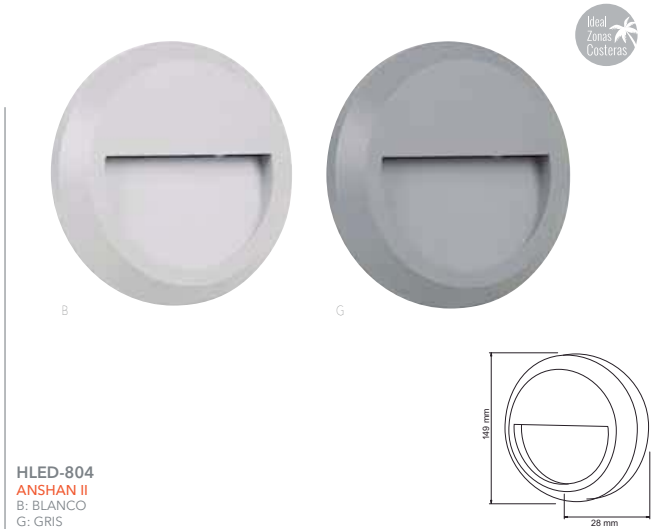

HLED-804
ANSHAN II
B: BLANCO
G: GRIS

PRODUCTO	TERMINADO DEL PRODUCTO	APLICACIÓN	LÚMENES	POTENCIA	VOLTS	TEMPERATURA DE COLOR	IRC	TIEMPO DE VIDA	TIPO DE LÁMPARA	ÁNGULO	INCLUYE	IP	OBSERVACIONES
HLED-802/B	Blanco	Muro	200 lm	2.5 W	100-127 V ~	4000K	80	15 000 h	LED	-	Driver LED	65	Ahorrador
HLED-802/G	Gris	Muro	200 lm	2.5 W	100-127 V ~	4000K	80	15 000 h	LED	-	Driver LED	65	Ahorrador
HLED-806/S	Satinado	Muro	250 lm	9.5 W	100-240 V ~	3000K	80	20 000 h	LED	47°	Driver LED	65	Ahorrador
HLED-803/B	Blanco	Muro	100 lm	1 W	100-127 V ~	4000K	80	15 000 h	LED	-	Driver LED	65	Ahorrador
HLED-803/G	Gris	Muro	100 lm	1 W	100-127 V ~	4000K	80	15 000 h	LED	-	Driver LED	65	Ahorrador
HLED-804/B	Blanco	Muro	100 lm	1 W	100-127 V ~	4000K	80	15 000 h	LED	-	Driver LED	65	Ahorrador

*Tecnolite se reserva el derecho de modificar la información sin previo aviso y no se hace responsable por errores u omisiones en este documento.

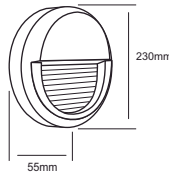

HLED-805/S
ANSHAN IV



HLED-800
ALEPPO II
B: BLANCO
G: GRIS

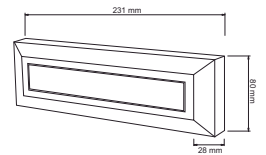

HLED-801
ANSHAN
B: BLANCO
G: GRIS

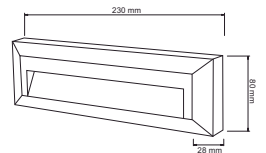

EXTERIOR / ACENTO / LUZ DE CORTESÍA LED

PRODUCTO	TERMINADO DEL PRODUCTO	APLICACIÓN	LÚMENES	POTENCIA	VOLTS	TEMPERATURA DE COLOR	IRC	TIEMPO DE VIDA	TIPO DE LÁMPARA	ÁNGULO	INCLUYE	IP	OBSERVACIONES
HLED-805/S	Satinado	Muro	250 lm	9.5 W	100-240 V ~	3000 K	80	20 000 h	LED	47°	Driver LED	65	Ahorrador
HLED-800/B	Blanco	Muro	200 lm	2.5 W	100-127 V ~	4000 K	80	15 000 h	LED	120°	Driver LED	65	Ahorrador
HLED-800/G	Gris	Muro	200 lm	2.5 W	100-127 V ~	4000 K	80	15 000 h	LED	120°	Driver LED	65	Ahorrador
HLED-801/B	Blanco	Muro	120 lm	1.5 W	100-127 V ~	4000 K	80	15 000 h	LED	-	Driver LED	65	Ahorrador
HLED-801/G	Gris	Muro	120 lm	1.5 W	100-127 V ~	4000 K	80	15 000 h	LED	-	Driver LED	65	Ahorrador

*Tecnolite se reserva el derecho de modificar la información sin previo aviso y no se hace responsable por errores u omisiones en este documento.



CR



N

HLED-920
CASPE I
CR: CROMADO
N: NEGRO

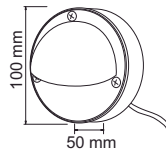

HLED-905/S
CERDEÑA

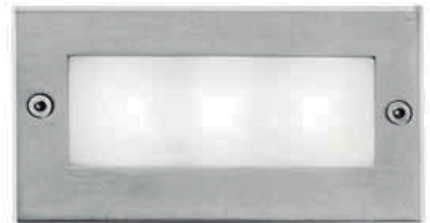
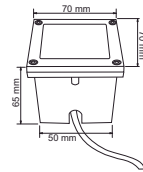

HLED-910/S
CERDEÑA I

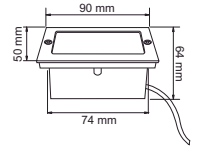

HLED-904/S
TULA I

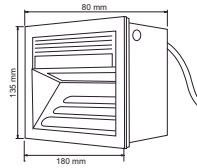

HLED-915/S
TWER

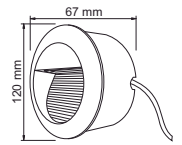

PRODUCTO	TERMINADO DEL PRODUCTO	APLICACIÓN	LÚMENES	POTENCIA	VOLTS	TEMPERATURA DE COLOR	IRC	TIEMPO DE VIDA	TIPO DE LÁMPARA	ÁNGULO	INCLUYE	CORTE DE EMPOTRAMIENTO	IP	OBSERVACIONES
HLED-920/CR	Cromado	Muro	50 lm	1 W	100-240 V ~	3000 K	80	20 000 h	LED	44°	Driver LED	-	45	Ahorrador
HLED-920/N	Negro	Muro	50 lm	1 W	100-240 V ~	3000 K	80	20 000 h	LED	44°	Driver LED	-	45	Ahorrador
HLED-905/S	Satinado	Empotrado en muro	4 lm	0.6 W	100-127 V ~	3000 K	80	15 000 h	LED	120°	Driver LED	50 mm x 50 mm	65	Ahorrador
HLED-910/S	Satinado	Empotrado en muro	4 lm	0.6 W	100-127 V ~	3000 K	80	15 000 h	LED	120°	Driver LED	74 mm x 50 mm	45	Ahorrador
HLED-904/S	Satinado	Empotrado en muro	20 lm	3 W	100-127 V ~	3000 K	80	15 000 h	LED	120°	Driver LED	125 mm x 170 mm	44	Ahorrador
HLED-915/S	Satinado	Empotrado en muro	20 lm	1.4 W	100-127 V ~	3000 K	80	15 000 h	LED	120°	Driver LED	115 mm	45	Ahorrador

*Tecnolite se reserva el derecho de modificar la información sin previo aviso y no se hace responsable por errores u omisiones en este documento.



FLUORESCENTE

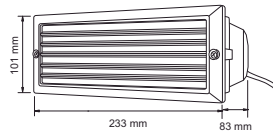

HLED-930/N
CASTILLO I

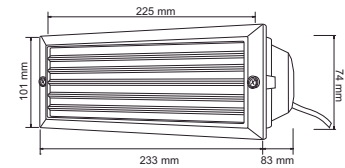
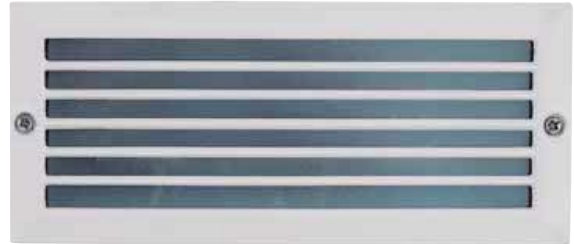

H-930/B
CASTILLO

EXTERIOR / ACENTO / LUZ DE CORTESÍA

LUZ DE CORTESÍA SIN LÁMPARA

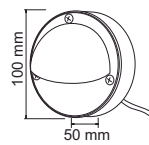

H-920/B
CASPE

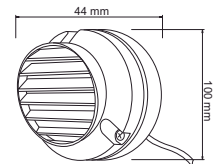

H-925
CASTELO
B: BLANCO
N: NEGRO

PRODUCTO	TERMINADO DEL PRODUCTO	APLICACIÓN	LÚMENES	POTENCIA	VOLTS	TEMPERATURA DE COLOR	IRC	TIEMPO DE VIDA	TIPO DE BASE	TIPO DE LÁMPARA	INCLUYE	CORTE DE EMPOTRAMIENTO	IP	OBSERVACIONES
HLED-930/N	Negro	Sobreponer en muro	200 lm	7 W	100-240 V ~	3000 K	80	15 000 h	LED	LED	Driver LED	230 mm x 95 mm	55	Ahorrador. Ángulo de 120°
H-930/B	Blanco	Sobreponer en muro	950 lm	13 W	100-127 V ~	2700 K	80	10 000 h	E27	HEL-13W	Lámpara	225 mm x 74 mm	45	Ahorrador
H-920/B	Blanco	Sobreponer en muro	-	20 W	100-240 V ~ / 12 V ~	-	-	-	G4	JC20	-	50 mm x 100 mm	45	Lámpara a 12 V requiere transformador
H-925/B	Blanco	Sobreponer en muro	-	20 W	100-240 V ~ / 12 V ~	-	-	-	G4	JC20	-	44 mm x 100 mm	45	Lámpara a 12 V requiere transformador
H-925/N	Negro	Sobreponer en muro	-	20 W	100-240 V ~ / 12 V ~	-	-	-	G4	JC20	-	44 mm x 100 mm	45	Lámpara a 12 V requiere transformador

*Tecnolite se reserva el derecho de modificar la información sin previo aviso y no se hace responsable por errores u omisiones en este documento.

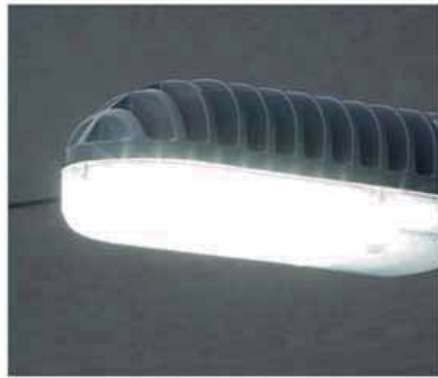

VIVE LA
SEGURIDAD DE LA LUZ
PARA EXTERIORES
INDUSTRIAL



LED

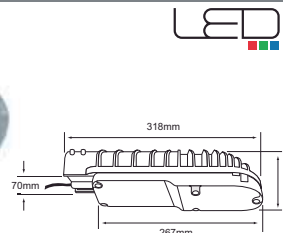

ES-LED/040/65
KAPPA

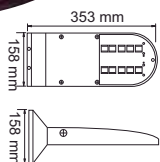

ES-LED/35W/40
BUQUE

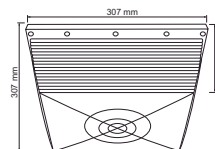

CF-236LED
ENZO

HID

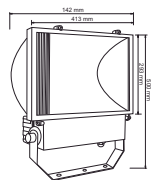

DFL-400-A S/E
BENEVENTO

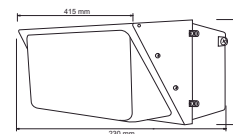

WPM-400/SE
ALBACETE I

PRODUCTO	TERMINADO DEL PRODUCTO	APLICACIÓN	LÚMENES	POTENCIA	VOLTS	TEMPERATURA DE COLOR	IRC	TIEMPO DE VIDA	TIPO DE BASE	TIPO DE LÁMPARA	ÁNGULO	INCLUYE	IP	OBSERVACIONES
ES-LED/040/65	Satinado	Punta de poste	3 600 lm	40 W	100-240 V ~	6500 K	80	30 000 h	LED	LED	110°	Driver LED	65	Ahorrador
ES-LED/35W/40	Café	Muro	1 900 lm	35 W	100-240 V ~	4000K	80	35 000 h	LED	LED	120°	Driver LED	65	Ahorrador
CF-236LED	Blanco	Sobreponer en techo	2 450 lm	25 W	100-240 V ~	6500 K	80	25 000 h	-	LED	120°	Driver LED	55	Ahorrador
DFL-400-A S/E	Negro	Aplicación en piso o muro	-	400 W	220 V ~	-	-	-	E40	AM1000W	-	-	55	Luminario sin equipo
WPM-400/SE	Café	Muro	-	400 W	220 V ~	-	-	-	E40	AM1000W	-	-	55	Luminario sin equipo

*Tecnolite se reserva el derecho de modificar la información sin previo aviso y no se hace responsable por errores u omisiones en este documento.